

This Instrument Prepared by:  
Katherine G. Jones  
Upchurch Bailey and Upchurch, P.A.  
Post Office Drawer 3007  
St. Augustine, Florida 32085  
File No. 4-04-433

**DECLARATION OF CONDOMINIUM**  
**FOR**  
**LAKEVIEW CONDOMINIUM**

**TABLE OF CONTENTS**

	<u>Page</u>
1. PURPOSE.....	1
2. DEFINITIONS.....	1
3. PROPOSED PLAN OF DEVELOPMENT .....	2
4. UNIT BOUNDARIES, COMMON ELEMENTS AND LIMITED COMMON ELEMENTS.....	3
5. OWNERSHIP .....	4
6. RESTRAINT UPON SEPARATION AND PARTITION OF COMMON ELEMENTS .....	5
7. PERCENTAGE OF OWNERSHIP OF COMMON ELEMENTS AND LIABILITY FOR COMMON EXPENSES.....	5
8. MAINTENANCE, ALTERATIONS AND IMPROVEMENTS.....	5
9. USE OF CONDOMINIUM PROPERTY.....	6
10. EASEMENTS .....	8
11. ASSOCIATION.....	9
12. INSURANCE .....	9
13. CONDEMNATION AND TOTAL OR PARTIAL LOSS OR DESTRUCTION.....	12
14. COMMON EXPENSES, COMMON SURPLUS, AND ASSESSMENTS.....	13
15. COMPLIANCE AND DEFAULT .....	14
16. AMENDMENT .....	15
17. NOTICE TO MORTGAGEES .....	16
18. TERMINATION .....	16
19. CONSTRUCTION .....	17

**DECLARATION OF CONDOMINIUM**

**FOR**

**LAKEVIEW CONDOMINIUM**

**THIS DECLARATION OF CONDOMINIUM** is made and executed this <sup>4<sup>th</sup></sup> ~~26~~ day of ~~May~~, 2005, by The Farber Family Partnership, a California limited partnership ("the Developer"), as owner of the real property described on Exhibit A, for itself and its successors, grantees, assignees and transferees.

**1. PURPOSE.** The purpose of this Declaration is to submit the lands described in Exhibit A and the improvements to be constructed on such lands to the condominium form of ownership and use as provided by Chapter 718, Florida Statutes ("the Condominium Act"), and the Developer does hereby submit such lands and improvements to the condominium form of ownership and use. The provisions of the Condominium Act are hereby adopted and shall govern the condominium and the rights, duties, and responsibility of Owners except where permissive variances appear in the Declaration, Bylaws, or Articles of Incorporation of Lakeview of St. Augustine Condominium Association, Inc.

**1.1** The name by which this Condominium is to be identified is Lakeview Condominium.

**1.2** The address of the Condominium is 172-180 Cordova Street, St. Augustine, Florida 32084.

**1.3** The lands which by this instrument are submitted to the condominium form of ownership are those certain lands lying in St. Augustine, St. Johns County, Florida, described in Exhibit A attached to and made part of this Declaration ("the Land"). The Land will be subject to the conditions, restrictions, limitations, easements, and reservations of record.

**1.4** All provisions of this Declaration will be construed to be perpetual covenants running with the Land or any part thereof or interest therein, and every Owner and claimant of the Land or any part thereof or interest therein, and his heirs, personal representatives, successors and assigns, shall be bound by all of the provisions of this Declaration, unless this Declaration is terminated pursuant to its terms or the Condominium Act. Both the burdens imposed by and the benefits of this Declaration shall run with each Condominium Parcel.

**2. DEFINITIONS.** The terms used in this Declaration and in the Articles of Incorporation, the Bylaws, and the Rules and Regulations shall have the meaning stated in the Condominium Act and as follows, unless the context otherwise requires:

**2.1** "Assessment" means a share of the funds required for the payment of Condominium Common Expenses, which from time to time is assessed against a Unit.

**2.2** "Association" means Lakeview of St. Augustine Condominium Association, Inc., the corporate entity responsible for the operation of the Condominium.

**2.3** "Association Property" means that property, real and personal, which is owned or leased by the Association for the use and benefit of its members.

**2.4** "Board of Administration" or "Board" means the board of directors or other representative body responsible for administration of the Association.

**2.5** "Bylaws" means the Bylaws of the Association existing from time to time.

**2.6** "Common Elements" means the portions of the Condominium Property not included in the Units, as further described in Section 4.2.

2.7 "Common Expenses" means all expenses properly incurred by the Association in the performance of its duties, including without limitation expenses specified in Section 718.115, Florida Statutes (2004), as amended from time to time.

2.8 "Common Surplus" means the amount of all receipts or revenues, including without limitation all assessments, rents, or profits, collected by the Association which exceed Common Expenses.

2.9 "Condominium" means Lakeview Condominium.

2.10 "Condominium Parcel" means and individual Unit as defined in Section 2.20 below, together with the undivided share in the Common Elements and all easements, rights, and interests appurtenant to the Unit

2.11 "Condominium Property" means the lands, leaseholds, and personal property that are subject to condominium ownership pursuant to this Declaration and any amendments, and all improvements thereon and all easements and rights appurtenant thereto intended for use in connection with the Condominium.

2.12 "Declaration" means this Declaration of Condominium for Lakeview Condominium, the instrument by which the Condominium is created, as amended from time to time.

2.13 "Developer" means the person or entity which creates the Condominium or offers Condominium Parcels for sale or lease in the normal course of business, but does not include an Owner or lessee who has acquired his Unit for his own occupancy. The Developer of this Condominium is The Farber Family Partnership.

2.14 "Governing Documents" means the Declaration, the Articles of Incorporation, the Bylaws, and the rules and regulations adopted by the Board of Administration.

2.15 "Institutional Mortgagee" means the Owner and holder of a mortgage encumbering a Condominium Parcel, which owner and holder of said mortgage shall be either a bank, life insurance company, federal or state savings and loan association, real estate or mortgage investment trust, federal or state agency, the Developer, or other mortgagee which shall be acceptable to and approved by the Board of Administration. "Institutional First Mortgagee" means an Institutional Mortgagee holding a first mortgage encumbering a Condominium Parcel.

2.16 "Limited Common Elements" means those Common Elements which are reserved for the use of a certain Condominium Unit or Units to the exclusion of other Units, as specified in this Declaration.

2.17 "Owner" means the record owner of legal title to a Condominium Parcel and shall include the Developer.

2.18 "Unit" means a constructed residential dwelling unit as more particularly described in Section 4.1 below, the part of the Condominium Property that is subject to exclusive ownership.

2.19 "Utility Services" as used in the Condominium Act, as construed with reference to this Condominium, and as used in this Declaration and all exhibits attached thereto, shall include without limitation electric power, hot and cold water, garbage and sewage disposal, heating and refrigeration, and other services required by governmental authorities.

**3. PROPOSED PLAN OF DEVELOPMENT.**

**3.1 Development Plans.** The development plans for the Condominium consist of the following, which are attached to and incorporated into this Declaration:

3.1.1 Exhibit B: Identification of Units and Schedule of Shares;

3.1.2 Exhibit C- Sheet 1 ("C-1"): Surveyor's Certificate;

- 3.1.3 Exhibit C-Sheets 2-3 ("C-2"): Survey and Plot Plan;
- 3.1.4 Exhibit C-Sheet 4 ("C-4"): Building Floor Plan;
- 3.1.5 Exhibit C-Sheets 5-22 ("C-5"): Unit Floor Plans; and
- 3.1.6 Exhibit C-Sheet 23 ("C-23"): Elevations.

The survey meets the minimum technical standards set forth by the Board of Professional Land Surveyors as required by the Condominium Act.

**3.2 Improvements.** The Condominium shall consist of one two-story building containing 12 single-story Units and 1 two-story Unit, and parking as depicted on Exhibit C-2. The Units are identified and described on Exhibits B and C-4.

**3.3 Legal Descriptions of Units.** The legal description of each Condominium Parcel shall consist of the identifying number and letter of the Unit in such Condominium Parcel as set forth on Exhibit B, as amended from time to time. Every deed, lease, mortgage, or other instrument shall legally describe a Condominium Parcel by its identifying letter as set forth on Exhibit B and each and every such description shall be deemed good and sufficient for all purposes.

**3.4 Combined Units.** Where more than one Unit has been acquired by the same Owner and combined into a single unit, the floor plans described in Exhibit C-5 may not reflect the interior plans of the combined Units, but the exterior boundaries of the combined Units shall remain the same. Should any Units be combined, such combined Units shall exist as separate Units as described in this Declaration for the purpose of applying the provisions of this Declaration. Such combination of Units by a Unit Owner other than the Developer shall not require an amendment to the Declaration.

#### 4. UNIT BOUNDARIES, COMMON ELEMENTS AND LIMITED COMMON ELEMENTS.

**4.1 Boundaries.** The boundaries of the Units shall be as follows:

##### 4.1.1 Upper and Lower.

**4.1.1.1 Units 1 through 12.** The upper boundaries of Units 1 through 12 shall be the horizontal plane of the undecorated, finished ceiling and the lower boundaries of such Units shall be the horizontal plane of the undecorated, finished floor, both of which shall extend to the intersection with the perimetrical boundaries of the Unit as defined below.

**4.2.1.2 Unit 13:** The upper boundary of Unit 13 shall be the horizontal plane of the undecorated, finished second-floor ceiling and the lower boundary of Unit 13 shall be the horizontal plane of the undecorated, finished first floor, both of which shall extend to the intersection with the perimetrical boundaries of the Unit as defined below.

**4.1.2 Perimetrical.** The perimetrical boundaries of the Units shall be the vertical plane of the undecorated, unfinished inner surfaces of the walls bounding the Unit depicted on the floor plans attached as Exhibits C-4 and C-5, extended to intersections with themselves and the upper and lower boundaries. Where there is an opening in any perimetrical boundary of a Unit, including without limitation doors and windows, the Unit shall include the exterior unfinished surface of such opening. Units 11 and 12 shall include the enclosed Florida Room shown on Exhibit C, sheets 15 and 16.

**4.1.4 Further Definition.** The boundaries of a Unit shall not include all of those spaces and improvements lying within the undecorated, unfinished inner surfaces of the perimeter walls; those surfaces above the undecorated, finished ceilings; those surfaces below the undecorated,

finished floors, and shall exclude those spaces and improvements lying within the undecorated, unfinished inner surfaces of the interior bearing walls and partitions and all pipes, ducts, wires, conduits and other utilities for the furnishing of utility services to other Units or the Common Elements running through any interior wall or partition.

**4.2 Common Elements.** The Common Elements of the Condominium shall consist of all of the real property, improvements, and facilities of the Condominium other than the Units. The Common Elements shall include without limitation the Limited Common Elements described in Section 4.3 and:

**4.2.1** All portions of the Condominium building contributing to the support of the building, including without limitation the exterior walls and all fixtures on its exterior; those portions of boundary walls not part of the Units, floor and ceiling slabs, and load-bearing columns, walls, and partitions.

**4.2.2** All conduits, ducts, plumbing, and wiring up to their outlets and all wells, pumps, and other facilities for the furnishing of Utility Services to any Unit or the Common Elements, regardless of their location.

**4.2.3** The parking areas, walkways, driveways, drainage structures, and any bicycle racks, grills, and other amenities provided by the Developer or the Association.

**4.2.4** The property and installation required for the furnishing of utilities and services to more than one Unit or to the Common Elements, including without limitation the well pumps, well alarms, and irrigation system.

**4.2.5** Easements for the maintenance of the Common Elements and the easements set forth in Section 10.

**4.3 Limited Common Elements.** The following Common Elements shall be Limited Common Elements for the exclusive use of the Owner of the Units described below:

**4.3.1 Equipment and Fixtures.** Appurtenant to each Unit shall be the equipment, fixtures, and appurtenances serving only his Unit (including without limitation all windows, screens, and exterior doors) and all equipment, plumbing, pipes, wiring, ducts, conduits and connections required to provide Utility Services to the Unit (including without limitation all air conditioning and heating compressors and equipment, fans, equipment, and fixtures), but excluding equipment and appurtenances serving more than one Unit.

**4.3.2 Porches.** The rear porches shown on Exhibit C-2 shall be Limited Common Elements for the exclusive use of the Unit or Units to which such porch is appurtenant.

**4.3.3 Stairways and Landings.** The exterior steps, stairways and landings shown on Exhibits C-2 and the interior stairways and landings shown on Exhibit C, sheets 17 through 22 are Limited Common Elements for the exclusive use of the Units served by such stairways and landings.

**4.3.4 Storage Buildings and Spaces.** The attached storage building shown on Exhibit C-2 and the storage spaces under the interior stair landings are Limited Common Elements for the exclusive use of the Association. The detached wood storage buildings shown on C-2 will be removed by the Developer.

## 5. OWNERSHIP.

**5.1 Type.** Ownership of each Condominium Parcel may be in fee simple or in any other estate in real property recognized by Florida law, and shall be subject to this Declaration.

**5.2 Association Membership.** The record Owners of Condominium Parcels shall be members of the Lakeview of Augustine Condominium Association, Inc., as more fully set forth in Section 11.

**5.3 Owner's Rights.** The Owner of a Condominium Parcel is entitled to exclusive possession of his Unit and shall be entitled to use the Common Elements in accordance with the purposes for which they are intended, but no such use shall hinder or encroach upon the lawful rights of Owners of other Condominium Parcels. There shall be a joint use of the Common Elements and a joint mutual easement for that purpose is hereby created. Each Owner shall take title to his Condominium Parcel subject to the terms of this Declaration, including without limitation the nonexclusive easements specified in Section 10.

**5.4 Registry of Owners.** The Association shall at all times maintain a register setting forth the names and addresses of all Owners of Condominium Parcels and all holders, insurers, and guarantors of mortgages on the Units who have notified the Association in writing of their names and addresses.

**5.5 Time Share Prohibited.** There are no time share estates created by this Declaration, nor will any be created in the Condominium.

**6. RESTRAINT UPON SEPARATION AND PARTITION OF COMMON ELEMENTS.** The fee title to each Condominium Parcel shall include the Unit, an undivided interest in the Common Elements, and the Limited Common Elements appurtenant to such Unit. An undivided interest in the Common Elements is deemed to be conveyed or encumbered with its entire respective Condominium Parcel, even though the description in the instrument of conveyance may refer only to the fee title to the Unit or a portion thereof. The share in the Common Elements appurtenant to a Unit cannot be conveyed or encumbered except together with the Unit. Any attempt to separate or any action to partition the fee title to a Unit from the undivided interest in such Common Elements appurtenant to such Unit shall be null and void.

**7. PERCENTAGE OF OWNERSHIP OF COMMON ELEMENTS AND LIABILITY FOR COMMON EXPENSES.** Each Owner shall own an undivided share in the Common Elements and Common Surplus of the Condominium and an undivided share of the liability for Common Expenses. The ownership share of the Common Elements and Common Surplus and share of liability for the Common Expenses assigned to each Unit shall be based upon the total square footage of each Unit in uniform relationship to the total square footage of each other Unit and is set forth in the Unit Identification and Schedule of Shares attached as Exhibit B.

**8. MAINTENANCE, ALTERATIONS AND IMPROVEMENTS.**

**8.1 Common Elements.** The Association shall operate, maintain, repair and replace the Common Elements and all portions of a Unit contributing to the support of the Condominium building; provided, however, that the Association shall not be responsible for the operation, maintenance, repair and replacement of the Limited Common Elements described in Section 4.3.1.

**8.2 Units.** Each Owner shall maintain, repair, and replace, at his expense his Unit, any interior finishes, decorating, furnishings, and accessories which such Owner places or maintains in his Unit, and the Limited Common Elements described in Section 4.3.1.

**8.3 Alterations by Owners.** No Owner may make any additions or alterations to or remove any portion of a Unit that is to be maintained by the Association, or do anything that would jeopardize the safety or soundness of a Condominium building or impair any easements, without first obtaining the written approval of the Board of Administration. A copy of the plans for such work, which must be prepared by an architect licensed by the state of Florida, shall be filed with the Association prior to the start of such work. An Owner may not paint or otherwise change the appearance of any portion of the Common Elements, including without limitation the exterior surfaces of his Unit. The Association shall determine the exterior color scheme of all buildings in the Condominium and shall be responsible for the maintenance of all exterior finishes. This section shall not apply to the Developer.

**8.4 Alterations by the Association.** The Common Elements and Association Property may be materially altered or substantially added to in accordance with this Section and Section 718.113(2), Florida Statutes (2004), as amended from time to time. Whenever in the judgment of the

Board of Administration the Condominium Property shall require additions, alterations, or improvements (in addition to the usual items of maintenance), and the making of such additions, alterations or improvements has been approved by at least seventy-five percent (75%) of the Owners and the Developer (if the Developer holds one or more units for sale in the ordinary course of business), the Board of Administration shall proceed with such additions, alterations, or improvements and shall specially assess all Owners for the cost as a Common Expense. Notwithstanding the foregoing, any alteration or modification described in Sections 718.110(4) and (8), Florida Statutes, must be approved in accordance with those sections.

**8.5 Alterations by Developer.** While the Developer is the owner of Unit 13, the Developer may alter the interior floor plan of Unit 13 to add or relocate interior partitions and to add fixtures and equipment. Such alterations shall not require the approval of the Association or the Unit Owners, and shall be evidenced by an amendment to the Declaration executed by the Developer to reflect the altered floor plan of Unit 13.

**8.6 Enforcement of Maintenance and Right of Entry.** The Association shall have the irrevocable right of access to each Unit during reasonable hours when necessary for the maintenance, repair, or replacement of any Common Elements or any portion of a Unit that is to be maintained by the Association pursuant to this Declaration, or as necessary in the Board of Administration's reasonable judgment to prevent damage to the Common Elements or a Unit. The Association shall have the right to take any or all such steps as may be necessary in the Board of Administration's reasonable judgment to maintain, repair, or replace such Common Elements or to prevent such damage. Nothing in this Section shall require the Association to maintain or repair any part of any Unit. The Association shall also have the right to proceed in any appropriate court to seek compliance with a Unit Owner's maintenance obligations and to enforce the Association's right of entry. Any expenses incurred by the Association to enforce the maintenance obligations of a Unit Owner and the Association's rights shall be the responsibility of such Unit Owner.

**8.7 Limitation on Association Liability.** Notwithstanding the duty of the Association to maintain and repair certain parts of the Condominium Property, the Association shall not be liable to Owners or their tenants, guests, or invitees for injury or damage, other than the cost of maintenance and repair, caused by any latent condition of the property to be maintained and repaired by the Association, or caused by the elements or third parties.

## **9. USE OF CONDOMINIUM PROPERTY.**

**9.1 Occupancy.** The Units may be occupied only as a dwelling by the Owner or his tenant and such Owner's or tenant's immediate family members.

**9.2 Rentals.** Units may be rented, provided the occupancy is by no more than two (2) lessees and members of their immediate family, and provided the occupancy is for a minimum of seven (7) months. Time sharing, subleasing, and transient use of Condominium Parcels and the rental of individual rooms is prohibited. The tenants shall have all use right in the Condominium property and those Common Elements otherwise available for use generally by Owners and the Owner shall not have such rights except as a guest. All leases shall be in writing and shall be subject to this Declaration and the other Governing Documents. Nothing in this subsection shall interfere with the access rights of the Owner set forth in Chapter 83, Florida Statutes. No lease of a Condominium Parcel shall release or discharge the Owner from compliance with this Section or any of his other duties as Owner.

**9.3 Nuisances.** No nuisance shall be allowed on the Condominium Parcel, nor shall any use or practice which is a source of annoyance to Owners or which interferes with the peaceful possession and residential use of the Condominium Property be permitted. All parts of the Condominium Property shall be kept in a clean and sanitary condition, and no rubbish, refuse, or garbage shall be allowed to accumulate or any fire hazard be allowed to exist. No Owner shall permit any use of his Unit or of the Common Elements which will increase the rate of insurance on the Condominium Property.



**9.4 Lawful Use.** The Condominium Property shall not be used for any immoral, improper, offensive or unlawful use. All applicable laws, zoning ordinances, and regulations of all governmental bodies having jurisdiction over the Condominium Property shall be observed.

**9.5 Rules and Regulations.** The Board of Administration may adopt reasonable rules and regulations governing the use of the Common Elements, and shall furnish copies to all Unit Owners.

**9.6 Antennae, Aerials, Signage.** No signs, advertisements, flags, decorations, or notices of any type may be displayed from a Unit or on the Common Elements and no exterior antennas, aerials, or other devices for radio, cable, or television reception may be erected on the Condominium Property or the exterior of any Unit. Provided, however, that United States flags and the other official flags specified in Section 718.113(4), Florida Statutes (2004), may be displayed in accordance with that statute, as it may be amended from time to time.

**9.7 Storage.** The Common Elements may not be used for storage by the Unit Owners. An Owner shall not place or cause to be placed in the driveways, walkways, entranceways, hallways, stairwells, or in or on any other Common Elements any furniture, packages, equipment, or objects of any kind. The exterior storage space and stairwell storage areas are for the exclusive use of the Association.

**9.8 Parking.** There are thirteen (13) uncovered parking spaces on the Condominium Property. The Developer and the Association are authorized to grant a revocable license to each Unit Owner for the exclusive use of one parking space. Such license shall be personal to the Unit Owner, shall not become an appurtenance to a Unit or a Limited Common Element, and may not be assigned or transferred by the Unit Owner. Upon the sale of a Unit, the license shall terminate and the new Owner may apply to the Association to obtain a license to use a parking space. No parking space may be used for any purpose other than the parking of private passenger vehicles that are in operating condition. No other vehicles or objects, including without limitation commercial vehicles, motor homes, recreational vehicles, trailers, or boats may be parked or placed on the Condominium Property unless permitted by the Board of Administration. Overnight camping in vehicles is prohibited. No parking space may be used by any person other than an occupant of the Condominium who is an actual resident or by a guest of a resident while such guest is, in fact, visiting upon the premises.

**9.9 Window Coverings.** So as to maintain the Condominium's uniform appearance, the portions of all window coverings visible from the exterior of a Unit shall be white or such other color as may be determined by the Board of Administration.

**9.10 Pets.** No more than two (2) pets may be kept in any Unit. This limitation shall not apply to aquatic pets, birds, or other pets that are continuously confined to a cage or tank provided they are so confined, and reasonable numbers of such pets, in the sole reasonable judgment of the Board of Administration, may be kept in a Unit. The only permitted pets shall be typical domestic household pets, and no pet shall be allowed that is dangerous or a nuisance to other Unit Owners, in the sole reasonable judgment of the Board of Administration. Pets must be kept on a leash while outside the Owner's Unit.

**9.11 Lighting.** No external lighting may be installed on the Common Elements or any Unit without the prior approval of the Board of Administration. No lighting may be installed which alters the residential nature of the Condominium.

**9.12 Grills.** The use of gas or charcoal grills on the Condominium Property is prohibited except in areas designated by the Board of Administration.

**9.13 Storm Shutters.** The Board of Administration shall adopt hurricane shutter specifications for each building within the Condominium, which shall include the color, style, and other factors deemed relevant by the Board. Unit Owners must obtain the approval of the Board before installing hurricane shutters; however, the Board shall not refuse to approve the installation or replacement of hurricane shutters that conform to the specifications adopted by the Board.

**9.14 Common Elements and Limited Common Elements.** The Common Elements and Limited Common Elements shall be used only for the purposes for which they are intended.

**9.15 Developer's Use of Condominium Property.** Until the Developer has closed the sale of all Units in the Condominium, neither the Owners, the Association, nor the use of the Condominium Property by any person or entity shall interfere with the sale of Units. The Developer may make such use of the unsold Units and Common Elements as may facilitate such completion and sale, including without limitation maintenance of a sales office and model, the showing of the Condominium Property, and the display of signs.

**9.16 Right of Entry in Emergencies.** In the case of an emergency originating in or threatening any Unit or Common Elements, the Association shall have an immediate right to enter a Unit for the purpose of remedying or abating the cause of such emergency, regardless of whether the Unit Owner is present at the time. In order to exercise its rights under this Section, the Association may require each Owner to provide the Association with a key to his Unit. Only officers or agents of the Association bonded pursuant to Section 13.4 may have custody of Unit keys.

**10. EASEMENTS.** The Developer hereby creates for the benefit of the Condominium Property and reserves for itself the following easements, which are perpetual and non-exclusive unless otherwise stated. Each of these easements is a covenant running with the Land and, notwithstanding any of the other provisions of this Declaration, may not be substantially amended or revoked in such a way as to unreasonably interfere with their proper and intended use and purpose:

**10.1 Utilities.** As may be required for Utility Services in order to adequately serve the Condominium Property; provided, however, easements through a Unit shall only be according to the plans and specifications for the building or as the building is actually constructed, unless approved in writing by the Owner of such Unit.

**10.2 Support.** Of support for the benefit of all other Units and Common Elements in the building. Such easement shall burden every portion of the Units contributing to the support of the Condominium building or an adjacent Unit.

**10.3 Common Elements.** Over the Common Elements, in favor of all Owners of Units in the Condominium, for their use and the use of their guests for all proper and normal purposes, and for the furnishing of services and facilities for the enjoyment of each and every Owner.

**10.4 Air Space.** For the exclusive use of the air space occupied by a Unit as it exists at any particular time and as the Unit may be lawfully altered, and for the use of the area and air space occupied by air conditioning and heating equipment situated on or within the Common Elements but exclusively serving a Unit. Such easement shall be extinguished upon the permanent removal of such equipment, but the removal of the equipment for repair or replacement shall not be construed as permanent removal.

**10.5 Encroachments.** For encroachments onto the Common Elements by any Unit, provided that such encroachment is not caused by the purposeful or negligent act of an Owner; and for encroachments into a Unit by the Common Elements. Such easements shall exist for the continuance of such encroachments for so long as they may naturally exist.

**10.6 Overhangs.** For overhanging troughs, gutters, or downspouts and the discharge therefore of rainwater and the subsequent flow thereof over the Units and Common Elements.

**10.7 Pedestrian and Vehicular Traffic.** For pedestrian traffic over, through and across the sidewalks, paths, and driveways that exist from time to time on the Common Elements; and for vehicular traffic over, through, and across such portions of the Common Elements as may from time to time be paved and intended for such use.

**10.8 Developer's Reserved Easements.** In addition to the foregoing, the Developer hereby reserves for itself and its successors and assigns a nonexclusive easement over, across, and under the Land for pedestrian and vehicular ingress and egress and for the installation, maintenance, and operation of utilities for all purposes.

Notwithstanding anything to the contrary contained in this Declaration, the provisions of this Section shall not be subject to amendment by anyone other than the Developer until such time as the Developer has sold all of the Units in the Condominium held or to be held by the Developer in the normal course of business.

**11. ASSOCIATION.** In order to provide for the proficient and effective administration of the Condominium by the Owners of Condominium Parcels, a non-profit corporation designated as Lakeview of St. Augustine Condominium Association, Inc., has been organized under the laws of the state of Florida. This corporation shall operate and manage the Condominium and undertake and perform all incidental acts and duties in accordance with the terms of this Declaration and with the Articles of Incorporation and Bylaws attached as Exhibits D and E, as amended from time to time.

**11.1 Restraint Upon Assignment of Shares.** The shares of members of the Association in the funds and assets of the Association cannot be assigned, hypothecated, or transferred in any way except as an appurtenance to a Unit.

**11.2 Membership.** All record Owners of Condominium Parcels shall be members of the Association, and no other persons or entities shall be entitled to membership except for subscribers to the Articles of Incorporation. Membership shall be established by acquisition of a legal interest in a Condominium Parcel, whether by conveyance, devise, judicial decree, or otherwise, and by the recordation in the public records of St. Johns County, Florida, of the deed or other instrument establishing the acquisition of such interest. Membership shall be subject to the terms of this Declaration and the Governing Documents.

**11.3 Voting.** On all matters as to which the membership is entitled to vote, there shall be only one (1) vote for each Condominium Parcel. Where a Condominium Parcel is owned by a corporation, partnership, or other legal entity or by more than one (1) natural person, all the Owners of such Condominium Parcel shall be collectively entitled to the vote assigned to such Condominium Parcel and such owners shall designate in writing an individual who shall be entitled to cast the vote on behalf of all the Owners. Such written designation shall be filed with the Association's secretary and shall be effective until changed in writing.

**12. INSURANCE.** At the expense of the Owners, the Association shall procure and maintain casualty and liability insurance on the Condominium and insurance or fidelity bonding of all persons who control or disburse funds of the Association. Such insurance shall be governed by the following provisions:

**12.1 Authority to Purchase.** All such insurance policies shall be purchased by the Association for the benefit of the Association and the Owners and their mortgagees, as their interests may appear, and provision shall be made for the issuance of certificates or mortgagee endorsements to such mortgagees.

**12.2 Insurance Trustee.** The Association may name as an insured, on behalf of the Association, the Association's authorized representative ("the Insurance Trustee"), who shall have exclusive authority to negotiate losses under any policy providing property or liability insurance and to perform other functions as necessary to accomplish this purpose.

Each Owner, by acceptance of a deed to a Condominium Parcel, hereby appoints the Association or the Insurance Trustee as his attorney-in-fact for the purpose of purchasing and maintaining such insurance, collecting and disposing of the proceeds therefore, negotiating losses and executing releases of liability, executing all documentation, and the performance of all other acts necessary to accomplish this purpose. The Insurance Trustee shall not be liable for payments of premiums, the renewal or sufficiency of the policies, or the failure to collect any insurance proceeds.

**12.3 Casualty Insurance.**

**12.3.1 Property Insured.** Every hazard insurance policy issued to protect the Condominium shall be in amount equal to the maximum insurable replacement value, excluding land, foundation, and excavation costs, as determined annually by the Board of Administration, and shall provide primary coverage for:

**12.3.1.1** All portions of the Condominium Property located outside the Units;

**12.3.1.2** The Condominium Property located inside the Units as such property was initially installed, or replacements thereof of like kind and quality and in accordance with the original plans and specifications or, if the original plans and specifications are not available, as they existed at the time the Unit was initially conveyed by the Developer; and

**12.3.1.3** Any other portions of the Condominium Property that the Association is required to maintain at the Association's expense.

The term "Condominium Property" shall exclude all floor, wall and ceiling coverings, electrical fixtures, appliances, air conditioner or heating equipment, water heaters, water filters, built-in cabinets and countertops, and window treatments, including curtains, drapes, blinds, hardware and similar window treatment components, or replacements of any of the foregoing which are located within the boundaries of a Unit and serve only one Unit, and all air conditioning compressors that service only one Unit, whether or not located within the Unit boundaries.

**12.3.2 Coverage.** Such coverage shall, at a minimum, provide protection against:

**12.3.2.1** Loss or damage by fire and other hazards covered by a standard extended coverage endorsement.

**12.3.2.2** Flood disaster insurance, if the Condominium is located in an area which has been officially identified by the appropriate governmental authority as having special flood hazards for which flood insurance has been made available under the National Flood Insurance Program ("NFIP"). Such policy shall, at a minimum, provide coverage in an amount equal to the lesser of the maximum coverage available under the NFIP for all buildings and other insurable property within the Condominium (to the extent that such buildings and property are within an area having special flood hazards), or one hundred percent (100%) of the current "replacement cost" of all such buildings and other insurable property. Such policy shall be in a form which meets the criteria set forth in the most current guidelines on the subject issued by the Federal Insurance Program.

**12.3.2.3** Such other risks as from time to time shall be customarily covered with respect to condominiums similar in construction, location, and use, including without limitation vandalism, malicious mischief, and all perils normally covered by an "all-risk" endorsement.

**12.3.2.4** If available, the policy shall include a construction cost endorsement if the Condominium is subject to a construction code provision that would become operative and require changes to undamaged portions of the building, thereby imposing significant costs in the event of partial destruction of the Condominium by an insured hazard.

In addition, such policies shall include an "agreed amount endorsement" and, if available, an "inflation guard endorsement." Adequate insurance may include reasonable deductibles as determined by the Board of Administration.

**12.4 Officers and Agents.** The Association shall maintain adequate insurance or fidelity bonding of all persons who control or disburse funds of the Association, including without limitation those individuals authorized to sign checks on behalf of the Association and the president, secretary, and treasurer of the Association. The insurance policy or fidelity bond must cover the maximum funds that will be in the custody of the Association or its management agent at any one time.

**12.5 Liability.** The Association shall maintain liability insurance in such amounts and with such coverage as shall be required by the Board of Administration, with cross liability endorsements to cover the liability of the Owners as a group to an Owner.

**12.6 Worker's Compensation.** The Association shall maintain Worker's Compensation insurance as required by applicable law.

**12.7 Premiums.** Premiums for insurance policies purchased by the Association pursuant to this Section and the cost of fidelity bonding shall be paid by the Association and shall be a Common Expense.

**12.8 Proceeds.** All insurance policies purchased by the Association under this Section shall be for the benefit of the Association and the owners and mortgagees of the Condominium Parcels, and shall provide that all proceeds covering casualty losses shall be paid to the Association or to the Insurance Trustee.

**12.8.1 Common Elements.** Proceeds on account of Common Elements shall be held in as many undivided shares as there are Condominium Parcels, the shares of each Owner being the same as his share in the Common Elements.

**12.8.2 Condominium Parcels.** Proceeds on account of Condominium Parcels shall be held in the following undivided shares:

**12.8.2.1 Partial Destruction.** When a building is to be restored pursuant to Section 13.2, for the Owners of the damaged Condominium Parcels in such building in proportion to the cost of repairing the damage suffered by each Owner.

**12.8.2.2 Total Destruction.** When a building is not to be restored pursuant to Section 13.2, for the Owners of all Condominium Parcels in such damaged building in proportion to their share of the Common Elements appurtenant to their Condominium Parcel.

**12.8.2.3 Mortgagees.** In the event a mortgagee endorsement has been issued as to a Unit, the share of the Owner shall be held in trust for the mortgagee and the Owner as their interests appear.

**12.9 Association as Agent.** The Association is hereby irrevocably appointed agent for each Condominium Parcel Owner to adjust all claims arising under insurance policies purchased by the Association.

**12.10 Owner's Obligations.** Each Owner shall, at his expense, purchase liability insurance to protect himself against claims due to accidents within his Unit and casualty insurance on all real and personal property located within the boundaries of his Unit (which is excluded from the coverage to be provided by the Association pursuant to Section 12.3) and the Limited Common Elements described in Section 4.3.1. All such insurance policies issued to individual Owners shall provide that the coverage afforded by such policies is in excess over the amount recoverable under any other policy covering the same loss without rights of subrogation against the Association. Each Owner shall provide the Association with evidence of his compliance with this section.

**12.11 Qualifications of Insurance Carriers.** The Association shall use generally acceptable insurance carriers. Only those carriers meeting the specific requirements regarding the qualifications of insurance carriers as set forth in the Federal National Mortgage Association Conventional Home Mortgage Selling Contract Supplement and the FHLMC Seller's Guide shall be used.

**12.12 Escrow for Insurance Proceeds.** Any Institutional First Mortgagee holding a mortgage upon a Condominium Parcel shall have the right to cause the Association to create and maintain an escrow account in the Association's name for the purpose of assuring the availability of funds with which to pay premiums due from time to time on insurance policies required under this Section 12, it being understood that the Association shall deposit in an escrow depository satisfactory to such Institutional First Mortgagee a monthly sum equal to one-twelfth ( $1/12^{\text{th}}$ ) of the annual amount of such insurance expense, and to contribute such other sums as may be required therefore, so that there shall be on deposit in escrow, at least one (1) month prior to the due date for

payment of premiums, a sum which will be sufficient to make full payment therefore. Such escrowed funds shall not be commingled with any other funds of the Association.

### 13. CONDEMNATION AND TOTAL OR PARTIAL LOSS OR DESTRUCTION.

**13.1 Condemnation Award.** The Association shall represent the Owners in the condemnation proceeds or in negotiations, settlement, and agreements with the condemning authority for acquisition of the Common Elements, or part thereof, by the condemning authority. Each Owner appoints the Association as attorney-in-fact for such purpose. In the event of a taking or acquisition of part or all of the Common Elements by a condemning authority, the award or proceeds of settlement shall be payable to the Association in trust for the Owners and Institutional Mortgagees as their interests appear.

**13.2 Reconstruction or Repair after Casualty or Condemnation.** As used in this section, "substantial loss, damage, or destruction" shall mean any loss, damage or destruction which renders more than fifty percent (50%) of the Units uninhabitable.

**13.2.1 Substantial Loss of Residential Buildings.** If substantial loss, damage or destruction is sustained, the Condominium shall be terminated unless within sixty (60) days from the date of loss the owners of two-thirds (2/3rds) of the Condominium Parcels and at least two-thirds (2/3rds) of the Institutional First Mortgagees agree in writing that the damaged property shall be repaired or reconstructed, or unless repair or reconstruction is required as a condition of payment under any policy of casualty insurance covering such loss.

**13.2.2 Less than Substantial Loss of Residential Buildings.** In the event damage sustained by the Condominium improvements is less than substantial as defined above, such damage shall be repaired unless within sixty (60) days from the date of loss all of the Owners and Institutional First Mortgagees agree in writing to terminate the Condominium in accordance with the procedure set forth in Section 18.

Any repair or restoration on account of physical damage shall restore the improvements to substantially the same condition as existed prior to the casualty, must be substantially in accordance with the plans and specifications for the construction of the original buildings, and shall be commenced and completed as expeditiously as possible. In no event shall any reconstruction or repair change the relative locations and approximate dimensions of the Common Elements and of any Condominium Parcel unless an appropriate amendment is made to this Declaration.

The Board of Administration may determine that it is in the best interests of the Association to pay the insurance proceeds into a construction fund to be administered by the Board. The Board of Administration shall not be required to cause such insurance proceeds to be made available to the Association prior to the completion of any necessary restoration, repairs, or reconstruction, unless arrangements are made by the Association to assure that such restoration, repairs, or reconstruction shall be completed. Such assurances may, without limitation, consist of obtaining a construction loan from other sources, entering into a binding contract for such restoration, repairs, or reconstruction, or obtaining performance or payment bonds.

**13.2.3 Common Elements.** Damage to the Common Elements shall be repaired unless the Condominium is to be terminated as provided above and in Section 18.

**13.3 Assessments.** If the proceeds of insurance are not sufficient to defray the estimated costs of reconstruction and repair by the Association, or if at any time during the reconstruction and repair the funds for payment of the costs thereof are insufficient, the Owners who own the damaged Condominium Parcels may be charged for the cost of reconstruction and repair. In the case of damage to the Common Elements, all Owners may be assessed in sufficient amounts to provide funds to pay the estimated costs. Charges for damage to Condominium Parcels shall be in proportion to the cost of reconstruction and repair of each Owner's respective damaged Condominium Parcel. Assessments on account of damage to the Common Elements shall be in proportion to the Owner's share of the Common Elements.

**14. COMMON EXPENSES, COMMON SURPLUS, AND ASSESSMENTS.** The making and collecting of assessments against Condominium Parcels for Common Expenses of the Condominium shall be the obligation of the Board of Administration pursuant to the Bylaws and subject the following:

**14.1 Share of Common Expenses and Common Surplus.** Each Owner of a Condominium Parcel shall bear a proportionate share of the total operating expenses and costs of the Condominium. Each Owner shall be responsible for a portion of such Common Expenses, and such share shall be in the percentage of the undivided share in the Common Elements appurtenant to such Owner's Condominium Parcel as set forth in Section 7. Any Common Surplus of the Condominium shall be owned by each of the Owners in the same proportion as their percentage liability for Common Expenses.

**14.2 Determination.** The Board of Administration shall propose annual budgets, including a Common Expense budget, in advance for each fiscal year. These budgets shall contain estimate of the cost of performing the functions of the Association and the cost of operating the Condominium. The Common Expenses shall include, without limitation, the estimated amounts necessary for the maintenance and operation of the Common Elements, replacement reserves, casualty insurance, liability insurance, and administrative salaries. The failure of the Board of Administration to include any item in the annual budget shall not preclude it from levying an additional assessment in any calendar year for which the budget has been projected. In determining the Common Expenses, the Board of Administration may provide for a contingency account not to exceed fifteen percent (15%) of the total projected Common Expenses for the year. Budget meetings shall be conducted in accordance with the Bylaws and the Condominium Act. One-twelfth (1/12<sup>th</sup>) of the annual Assessments shall be due and payable in advance to the Association on the first day of each month.

**14.3 Special Assessments.** Special Assessments may be made by the Board of Administration from time to time to meet other needs or requirements of the Association in the operation and management of the Condominium and to provide for emergencies, repairs, or replacement of Condominium Property and infrequently occurring items of maintenance. However, any Special Assessments which are not connected with an actual operating, managerial, or maintenance expense of the Condominium shall not be levied without the approval of a majority of the Owners.

**14.4 Non-Waiver.** The liability for Assessments may not be avoided by waiver of the use or enjoyment of any Common Elements or by abandonment of the Condominium Parcel for which the Assessment is made.

**14.5 Interest, Late Fees, and Application of Payments.** The Owner of each Condominium Parcel shall be personally liable to the Association for the payment of all Assessments, annual and special, and for all costs of collecting delinquent Assessments. In the case of more than one record Owner of a Condominium Parcel, each such Owner shall be jointly and severally liable with the other Owners of such Condominium Parcel for the payment of such Assessments. Assessments and installments on them which are not paid when due shall bear interest at the highest rate allowed by the laws of the State of Florida from the date when due until paid. An administrative late fee in the amount of \$25.00 or five percent (5%) of the unpaid Assessment or installment, whichever is greater, shall also be due on any late payment. Any payment received by the Association shall be applied first to any interest accrued by the Association, then to any administrative late fee, then to any costs and reasonable attorneys' fees incurred in collection, and then to the delinquent Assessment.

**14.6 Lien for Assessments.** The Association shall have a lien on each Condominium Parcel to secure unpaid Assessments, interest thereon, and all reasonable costs and attorneys' fees incurred by the Association incident to the collection process at all levels of the proceedings. Such lien shall be perfected and enforced in the manner set forth in the Condominium Act.

**14.7 Collection and Foreclosure.** The Board of Administration may take such action it deems necessary to collect Assessments, including bringing an action for damages against the Owner or foreclosing its lien, and may settle and compromise its claim if it deems such settlement or compromise is in the best interests of the Association. The Association shall be entitled to bid at any foreclosure sale and to apply as a cash credit against its bid all sums due the Association and covered by the lien being enforced.

**14.8 Assignment of Claim .** The Association shall have the right to assign its claim to any unpaid Assessments to the Developer, any Owner or group of Owners, or any third party.

**14.9 Certificate of Unpaid Assessments.** Any Owner and any holder of a mortgage on a Condominium Parcel shall have the right to require from the Association a certificate showing the amount of unpaid Assessments against that Condominium Parcel. The Association or its agent may charge a reasonable fee for the preparation of such certificate.

**14.10 Assessments on Developer-Owned Units.** As provided by Section 718.116(9)(a)(2), Florida Statutes (2004), the Developer shall be excused from payment of Assessments, annual and special, on Units it owns until October 1, 2005, or the date by which ninety percent (90%) of the Units in all proposed phases have been conveyed by the Developer, whichever occurs first ("the Guarantee Period"). The Developer may extend the Guarantee Period for up to two additional one-year periods. During the Guarantee Period the Developer guarantees that the maximum monthly installment of annual Assessments assessed against a Unit shall not exceed \$330.00 and obligates itself to pay any amount of Common Expenses incurred during the Guarantee Period that exceed Assessments at the guaranteed level receivable from other Unit Owners.

**15. COMPLIANCE AND DEFAULT.** Each Owner shall be governed by and shall comply with the terms of this Declaration, the other Governing Documents, and the Condominium Act, as they may be amended from time to time. The Association shall be entitled to the following remedies in addition to those otherwise available under the Condominium Act or other applicable law, which shall all be cumulative:

**15.1 Remedies for Violations.** In the event an Owner or an occupant of a Unit violates any provision of the Governing Documents or the Condominium Act, as they may be amended from time to time, the Association, the Owners, and the Institutional First Mortgagees, jointly and severally, shall have the right to proceed in an appropriate court for an action for damages or to compel compliance with the terms of those documents or for other appropriate relief. This right shall be in addition to the other remedies set forth in this Declaration or the Condominium Act.

**15.2 Fines.** The Association may levy reasonable fines as permitted by the Condominium Act for failure of an Owner or the occupant, licensee, or invitee of a Unit to comply with any provision of the Governing Documents.

**15.3 Costs and Attorneys' Fees.** In any proceeding arising out of the failure of an Owner or an occupant of a Unit to comply with the terms of the Governing Documents or the Condominium Act, the prevailing party shall be entitled to recover the costs of the proceeding and reasonable attorneys' fees as may be awarded by the court.

The failure of the Association or any Owner to enforce a covenant, restriction, or other provision of the Governing Documents or the Condominium Act shall not constitute a waiver of the right to do so thereafter. No breach of any of the provision contained in this Declaration shall defeat or adversely affect the lien of any valid first mortgage on a Condominium Parcel. Notwithstanding the foregoing, the rights and remedies granted by this Declaration may be enforced against the Owner of a Condominium Parcel subject to a mortgage notwithstanding such mortgage. The purchaser at any foreclosure sale shall be bound by all of the provisions of the Governing Documents and the Condominium Act.



**16. AMENDMENT.** Except as elsewhere provided otherwise, this Declaration may be amended in accordance with the following provisions:

**16.1 Notice.** Notice of a proposed amendment shall be included in the notice of any meeting at which the proposed amendment is considered in accordance with the requirements of Section 718.110(1)(b), Florida Statutes (2004), as amended from time to time and, if required by Section 18, shall be sent to holders, insurers, or guarantors of first mortgages in accordance with that Section.

**16.2 General Procedure.** A resolution adopting a proposed amendment may be proposed by either the Board of Administration or by the members of the Association. Except where elsewhere provided, approval of a proposed amendment must be by no less than two-thirds (2/3rds) of the Board of Administration and by no less than two-thirds (2/3rds) of the votes of the entire membership of the Association.

**16.3 Errors and Omissions.** Whenever it appears that there is an error or omission in this Declaration or any exhibit or amendment, a resolution adopting a proposed amendment to cure such error or omission may be proposed by either the Board of Administration or the members of the Association. Approval of such proposed amendment must be by no less than fifty percent (50%) of the Board of Administration and by no less than fifty percent (50%) of the votes of the entire membership of the Association.

**16.4 Amendments Affecting Developer.** Any amendment to this Declaration which affects the rights, privileges, power, or options of the Developer shall require the approval of the Developer.

**16.5 Amendments Requiring Unanimous Approval.** Except as otherwise provided in this Declaration, any amendment that changes the configuration or size of any Unit in a material fashion, materially alters or modifies the appurtenances to a Unit, or changes the proportion or percentage by which the Unit Owner shares the Common Expenses and owns the Common Surplus shall require the joinder of the Owners of all affected Units and must be approved by all other Owners.

**16.6 Amendments Materially Affecting Mortgagees.** Any amendment that operates to materially affect the rights or interests of any Institutional First Mortgagee shall require the consent of such Mortgagee, which consent shall not be unreasonably withheld.

**16.7 Application of Amendments Restricting Rental Rights.** Any amendment restricting Unit Owners' rights relating to the rental of Units applies only to Unit Owners who consent to the amendment and Unit Owners who purchase their Units after the effective date of the amendment.

**16.8 Amendment By Developer.** Notwithstanding anything to the contrary set forth in this Declaration, the Developer reserves the unilateral right to amend the Declaration to modify the interior floor plan of Unit 13 and for any other purpose, provided such amendment does not change the configuration or size of any Unit in any material fashion; materially alter or modify the appurtenances to any Condominium Parcel; change the proportion or percentage by which an Owner shares the Common Expenses and owns the Common Surplus; or permit timeshare estates to be created in any Condominium Parcel. An amendment by the Developer shall be evidenced by recording a written amendment in the public records of St. Johns County, Florida, that complies with the requirements of Section 718.110(1)(b), Florida Statutes (2004), as amended from time to time. Amendments authorized by this Section shall not require the approval of the Board of Administration, the Association, the Owners, or any lienors or mortgagees of Condominium Parcels.

**16.9 Amendment of this Section 16.** Notwithstanding anything to the contrary contained in this Declaration, this Section 16 concerning amendment cannot be amended without the consent of eighty percent (80%) of the Owners and the Developer, as long as the Developer holds any Units for sale. Section 16.6 cannot be amended without the consent of eighty percent (80%) of Institutional First Mortgagees, which consent shall not be unreasonably withheld.

**17. NOTICE TO MORTGAGEES.** The Association shall provide a holder, insurer, or guarantor of an Institutional First Mortgage that has registered its name with the Association, upon written request of such holder, insurer or guarantor, at least one copy of the annual financial statement or report of the Association, and notice of the following:

17.1 Any proposed amendment of the Condominium documents affecting a change in:

17.1.1 The boundaries of any Unit or the exclusive easement rights appurtenant thereto;

17.1.2 The interest in the Common Elements or Limited Common Elements appurtenant to any Condominium Parcel or the liability for Common Expenses appurtenant thereto;

17.1.3 The number of votes in the Association allocated to any Condominium Parcel; or

17.1.4 The purposes to which any Condominium Parcel or the Common Elements are restricted;

17.2 Any condemnation loss or casualty loss which affects a material portion of the Condominium or which affects any Condominium Parcel on which there is an Institutional First Mortgage;

17.3 Any proposed termination of the Condominium;

17.4 Any lapse, cancellation, or material modification of any insurance policy maintained by the Association; and

17.5 Any proposed action that requires the consent of a specified percentage of Institutional First Mortgagees.

**18. TERMINATION.** The Condominium may only be terminated in the following manners and in the manner set forth in the Condominium Act:

**18.1 Substantial Loss.** In the event that it is determined as provided in Section 14 that the Condominium shall not be reconstructed because of substantial loss, the condominium plan of ownership for the Condominium shall be terminated without the necessity of agreement or approval by the membership.

**18.2 Agreement.** The Condominium may be terminated by the approval, in writing, of all of the members of the Association and all Institutional First Mortgagees.

**18.3 Certificate.** The termination of the Condominium in either of the foregoing manners shall be evidenced by a written instrument of the Association, executed by all members and certified by the President and Secretary as to the facts effecting the termination, which certificate shall become effective upon being recorded in the public records of St. Johns County, Florida.

**18.4 Shares of Owners after Termination.** After termination of the Condominium, Owners shall own the Condominium Property and all assets of the Association as tenants in common in undivided shares, and their respective mortgagees and lienors shall have mortgages and liens upon the respective shares of the Owners in the same amount and with the same priorities as existed on the Owners' Condominium Parcels.

**18.5 Sale of Property.** Immediately after the required vote of consent to terminate, each and every Owner shall immediately convey to the Association by warranty deed all of such Owner's right, title and interest to his Condominium Parcel, provided the Association's officers and employees handling funds have first been adequately bonded. The Association or any member shall have the right to enforce such conveyance by specific performance. The Board of Administration shall then sell all of the Condominium Property at public or private sale, upon such terms as are approved in writing by all of the Institutional First Mortgagees. Upon the sale of the Condominium

Property, the costs, fees, and charges for the sale, the cost of liquidation of the Association, and costs incurred in connection with the management and operation of the Condominium Property up to and including the time when distribution is made to the Owners shall be paid out of the proceeds of the sale. The remaining balance ("the net proceeds of the sale") shall be distributed as follows:

**18.5.1 Determination of Distributive Share.** The distributive share of each Owner in the net proceeds of the sale, subject to the provisions of this Section, shall be in proportion to such Owner's undivided share in the Common Elements as set forth in Section 7.

**18.5.2 Payment of Liens.** Upon determination of each Owner's distributive share, the Association shall pay out of each Owner's distributive share all mortgages, Assessments, and other liens encumbering the Condominium Parcel in accordance with their priority of record, and upon such payment all mortgages, the Association, and lienors shall execute and record satisfactions or releases of their mortgages and liens, regardless of whether the same are paid in full.

**18.5.3 Payment to Owners.** After making the payments described in Section 18.5.2, the Directors shall proceed to liquidate and dissolve the Association and distribute the remaining portion of each distributive share, if any, to the Owner of such share. If a Condominium Parcel is owned by more than one person, the Association shall pay the remaining distributive share allocated to such Condominium Parcel to the various Owners of record.

**18.5.4 Disputes.** In the event there is a dispute over the validity, priority, or amount of mortgages or liens encumbering a Condominium Parcel, or in the event there is a dispute between Owners of a Condominium Parcel as to each Owner's share in such Condominium Parcel, then payment shall be made jointly to the parties to such dispute and, upon receipt of such joint payment, all parties to the dispute shall execute and deliver to the Association satisfactions and release of record of all liens against the Condominium Parcel.

**18.6 Effect of Termination.** After the certificate described in Section 18.3 is recorded, all Owners have conveyed their interests in the Condominium Property to the Association, and the Association has conveyed all of the Condominium Property to a purchaser, the title to the Condominium Property shall thereafter be free of all restrictions, reservations, covenants, conditions, and easements set forth in this Declaration.

## 19. CONSTRUCTION.

**19.1 Severability and Invalidity.** The invalidity, in whole or in part, of any covenant or restriction, or any section, subsection, sentence, clause, phrase or word, or other provision of this Declaration or the Governing Documents, shall not affect the validity of the remaining portions, which shall remain in full force and effect. In the event any court determines that any provision of this Declaration violates the rule against perpetuities or any other rule of law because of the duration of the period involved, the period specified in this Declaration shall not become invalid but instead shall be reduced to the maximum period allowed under such rule of law, and for such purpose the meaning lives shall be that of the incorporation of the Association.

**19.2 Headings.** The headings in this Declaration are for reference and in no way define, limit, or describe the scope of this Declaration.

**19.3 Gender.** The use of the masculine gender shall be deemed to refer to the feminine or neuter gender, and the use of the singular or plural shall refer to the other, as the context or application may require

**19.4 Intent.** The provisions of this Declaration of Condominium shall be liberally construed to effectuate its purpose of creating a uniform plan for the operation of a residential Condominium in accordance with the Condominium Act.

*[SIGNATURES ON FOLLOWING PAGE]*

IN WITNESS WHEREOF, the Developer, The Farber Family Partnership, has executed this Declaration of Condominium this 26 day of May, 2005.

Signed and sealed in the presence of :

FARBER FAMILY PARTNERSHIP,  
a California limited partnership

D. Tom  
Print name: Dave Tomon

Kathy Stone  
Print name: Kathy Stone

D. Tom  
Print name: Dave Tomon

Kathy Stone  
Print name: Kathy Stone

By: Curtis L. Farber  
Curtis L. Farber, as Trustee of the Farber Family Trust dated June 3, 1998  
Its General Partner

By: Stephanie A. Farber  
Stephanie A. Farber, as Trustee of the Farber Family Trust dated June 3, 1998  
Its General Partner

STATE OF California  
COUNTY OF San Diego

The foregoing instrument was acknowledged before me this 26 day of May, 2005, by Curtis L. Farber as Trustee of the Farber Family Trust dated June 3, 1998, as General Partner of The Farber Family Partnership. He is () personally known to me or ( ) has produced \_\_\_\_\_ as identification.

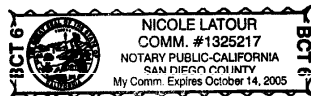

Nicole Latour  
Name: Nicole Latour  
Notary Public  
Commission No. 1325217  
Commission Expires 10/14/05

STATE OF California  
COUNTY OF San Diego

The foregoing instrument was acknowledged before me this 26 day of May, 2005, by Stephanie A. Farber as Trustee of the Farber Family Trust dated June 3, 1998, as General Partner of The Farber Family Partnership. She is () personally known to me or ( ) has produced \_\_\_\_\_ as identification.

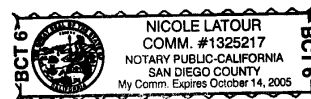

Nicole Latour  
Name: Nicole Latour  
Notary Public  
Commission No. 1325217  
Commission Expires 10/14/05

**JOINDER AND CONSENT OF MORTGAGEE**

First National Bank, the owner and holder of a mortgage on the real property described in the foregoing Declaration of Condominium, which mortgage is recorded in Official Records 2328, page 1201, of the public records of St. Johns County, Florida, hereby joins in and consents to the filing of said Declaration of Condominium as covenants running with the land and to the subordination of the lien of its mortgage to the terms of the aforesaid Declaration of Condominium. This Joinder and Consent shall be binding upon the undersigned and its successors and assigns.

Dated this 25<sup>th</sup> day of May, 2005.

Signed, sealed and delivered  
in the presence of:

Lisa Burke  
Name: LISA BURKE

John Minor  
By: \_\_\_\_\_  
Its: President  
Address: Post Office Box 6090  
St. Mary's, Georgia 31558

Danny E. Watkins  
Name: DANNY E. WATKINS

**STATE OF GEORGIA**  
**COUNTY OF Camden**

The foregoing instrument was acknowledged before me this 25 day of May, 2005, by John Minor, the President of First National Bank, on behalf of the Bank. He is personally known to me or has produced \_\_\_\_\_ as identification.

Fred He Vera  
Name: Fred He Vera  
Notary Public  
Commission No. \_\_\_\_\_  
Commission Expires \_\_\_\_\_

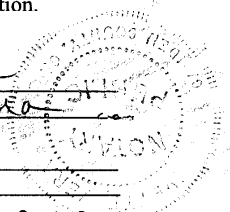

Notary Public, Camden County, Georgia  
My Commission Expires March 25, 2007

**EXHIBIT "A"**

**Legal Description of Real Property submitted to Condominium Ownership**

LEGAL DESCRIPTION

**DEED DESCRIPTION**

AS PROVIDED BY CLIENT ( OFFICIAL RECORD BOOK 1966, PAGE 1029 )

LOT NINETEEN (19) OF BLOCK 38-A OF THE CITY OF ST. AUGUSTINE, FLORIDA; BEING ALSO DESCRIBED AS FOLLOWS: COMMENCING AT THE INTERSECTION OF THE WEST LINE OF CORDOVA STREET WITH THE NORTH LINE OF ST. FRANCIS STREET; THENCE TWENTY (20) DEGREE, THIRTY (30) MINUTES WEST ALONG THE SAID WEST LINE OF CORDOVA STREET 292.5 FEET, THENCE AT RIGHT ANGLES SOUTH SIXTY-NINE (69) DEGREES, THIRTY (30) MINUTES WEST 86.2 FEET TO REAR LINE OF PROPERTY, THENCE SOUTH NINETEEN (19) DEGREES, FORTY-SEVEN (47) MINUTES EAST ALONG SAID REAR LINE 282 FEET, MORE OR LESS, TO THE NORTH LINE OF ST. FRANCIS STREET, THENCE NORTH SEVENTY-SIX (76) DEGREES, FORTY (40) MINUTES EAST ALONG SAID NORTH LINE OF STREET 90.35 FEET TO PLACE OF BEGINNING, TOGETHER WITH ALL RIGHT, TITLE AND INTEREST TO THOSE PART OF CORDOVA STREET, FORMERLY BRONSON STREET, AND ST. FRANCIS STREET BETWEEN THEIR BOUNDARIES AS HEREIN DESCRIBED, AND THE BOUNDARIES OF SUCH STREETS AS ESTABLISHED BEFORE THEIR WIDENING AND ESTABLISHED, OR BETWEEN THEIR PRESENT BOUNDARIES AND ANY DIVISION OR LOT LINES WHERE STREETS DID NOT PREVIOUSLY EXIST, BEING THE SAME PROPERTY CONVEYED BY HENRY M. FLAGLER TO FLORIDA EAST COAST HOTEL COMPANY, BY DEED DATED MARCH 15, 1898, AND RECORDED IN DEED BOOK No. 1, PAGES 421, 422 AND 423 OF THE PUBLIC RECORDS OF ST. JOHNS COUNTY, FLORIDA, AND ALSO DESCRIBED AS LOT NINETEEN (19), BLOCK 38-A, CITY OF ST. AUGUSTINE, FLORIDA, ACCORDING TO OFFICIAL MAP THEREOF RECORDED IN THE OFFICE OF THE CLERK OF THE CIRCUIT COURT IN AND FOR ST. JOHNS COUNTY, FLORIDA.

**EXHIBIT "B"**

**Unit Shares and Identification**



**UNIT IDENTIFICATION and SCHEDULE OF SHARES**

A Condominium Parcel shall be described as "Unit \_\_\_\_\_, Lakeview Condominium, as recorded in Official Records 2450 page 607, of the of the public records of St. Johns County, Florida."

The Units shall be numbered as shown on the building floor plan attached as Exhibit C-4. The undivided share of ownership in the Common Elements and Common Surplus appurtenant to each Unit, and the percentage of liability for Common Expenses is as follows:

Unit 1:	.068
Unit 2:	.076
Unit 3:	.090
Unit 4:	.090
Unit 5:	.090
Unit 6:	.092
Unit 7:	.084
Unit 8:	.091
Unit 9:	.086
Unit 10:	.088
Unit 11:	.057
Unit 12:	.066
Unit 13:	<u>.022</u>
Total:	1.000

**COMPOSITE EXHIBIT "C"**

**Survey, Plot Plan, and Floor Plans**

EXHIBIT "A"

SHEET 1 OF 23

SURVEYOR'S CERTIFICATE  
FOR  
LAKEVIEW CONDOMINIUM

STATE OF FLORIDA  
COUNTY OF ST. JOHNS

BEFORE ME, the undersigned authority duly authorized to administer oaths and take acknowledgements, personally appeared Michael A. Piesco, P.L.S., by me well known and known to me to be the person hereinafter described, who after being by me first duly sworn, deposes and says on oath as follows:

1. I am a professional land surveyor licensed and authorized to practice in the State of Florida.
2. I hereby certify that the construction of the Lakeview Condominium, is substantially complete so that the survey and plot plan, together with the provisions of the Declaration of Condominium describing the condominium, is an accurate representation of the location and dimension of the condominium and that the identification, location and dimension of the common elements and of each unit can be determined from these materials.
3. This certificate is not valid without pages 1-23 attached and made a part hereof.

IN WITNESS WHEREOF I have hereunto set my hand and official seal, this 11th day of February, 2005.

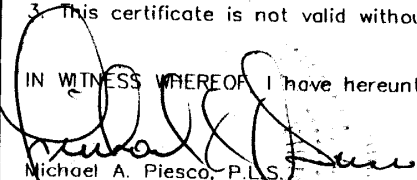
  
Michael A. Piesco, P.L.S.  
Professional Land Surveyor  
No. 4793, State of Florida

SWORN TO AND SUBSCRIBED before me this 11th day of February, 2005, by Michael A. Piesco, whi is personally known to me or who has produced Florida driver's license number P200-541-52-454-0 as identification.

Cindy Riddle  
Signature of Notary

Cindy Riddle  
Name of notary Typed / Printed / Stamped

Commission Number : \_\_\_\_\_

My commission Expires: \_\_\_\_\_



Cindy Riddle  
My Commission DD130083  
Expires June 30, 2006

EXHIBIT "A"

# LAKE VIEW CONDOMINIUM

SHEET 2 OF 23

NOT TO SCALE

WASHINGTON STREET

BRIDGE STREET

CORDOVA STREET

40' R/W - BAND



SEE SHEET 3 of 23  
FOR NOTES & LEGEND

PREPARED BY:  
ANCIENT CITY SURVEYING LBS# 7111  
3433 US-1 SOUTH  
ST. AUGUSTINE, FLORIDA 32086  
(904) 797-9967

ST. FRANCIS STREET

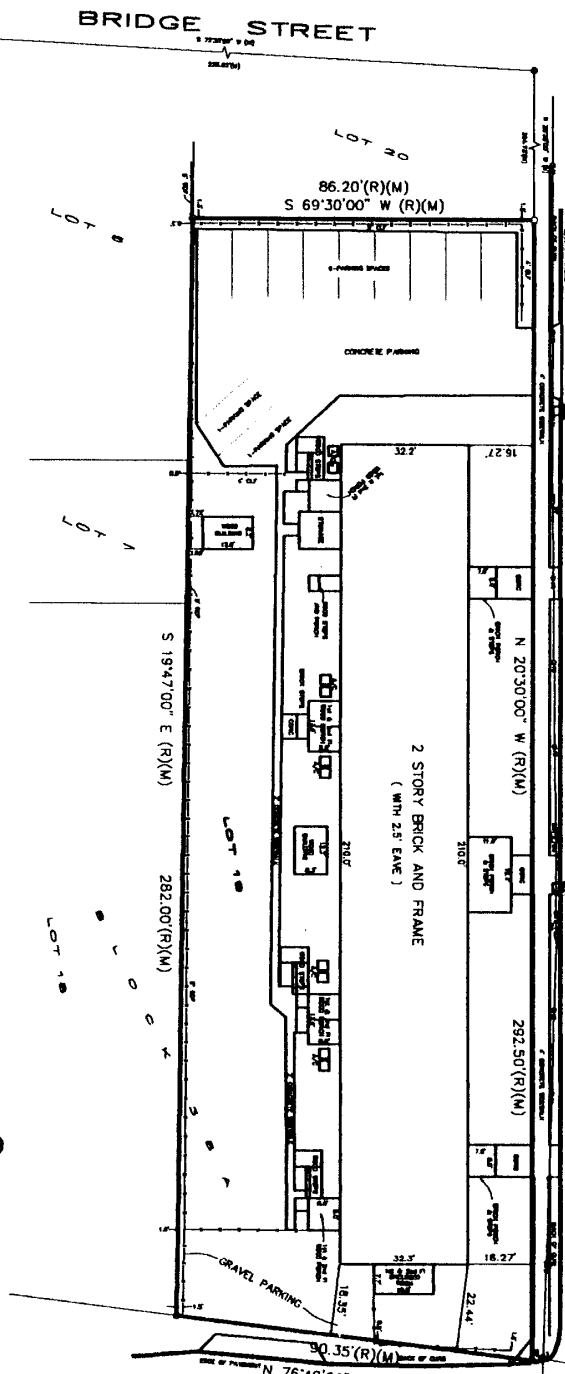

EXHIBIT "A"

SHEET 3 OF 23

**DEED DESCRIPTION**

AS PROVIDED BY CLIENT ( OFFICIAL RECORD BOOK 1966, PAGE 1029 )

LOT NINETEEN (19) OF BLOCK 38-A OF THE CITY OF ST. AUGUSTINE, FLORIDA; BEING ALSO DESCRIBED AS FOLLOWS: COMMENCING AT THE INTERSECTION OF THE WEST LINE OF CORDOVA STREET WITH THE NORTH LINE OF ST. FRANCIS STREET; THENCE TWENTY (20) DEGREE, THIRTY (30) MINUTES WEST ALONG THE SAID WEST LINE OF CORDOVA STREET 292.5 FEET, THENCE AT RIGHT ANGLES SOUTH SIXTY-NINE (69) DEGREES, THIRTY (30) MINUTES WEST 86.2 FEET TO REAR LINE OF PROPERTY, THENCE SOUTH NINETEEN (19) DEGREES, FORTY-SEVEN (47) MINUTES EAST ALONG SAID REAR LINE 282 FEET, MORE OR LESS, TO THE NORTH LINE OF ST. FRANCIS STREET, THENCE NORTH SEVENTY-SIX (76) DEGREES, FORTY (40) MINUTES EAST ALONG SAID NORTH LINE OF STREET 90.35 FEET TO PLACE OF BEGINNING, TOGETHER WITH ALL RIGHT, TITLE AND INTEREST TO THOSE PART OF CORDOVA STREET, FORMERLY BRONSON STREET, AND ST. FRANCIS STREET BETWEEN THEIR BOUNDARIES AS HEREIN DESCRIBED, AND THE BOUNDARIES OF SUCH STREETS AS ESTABLISHED BEFORE THEIR WIDENING AND ESTABLISHED, OR BETWEEN THEIR PRESENT BOUNDARIES AND ANY DIVISION OR LOT LINES WHERE STREETS DID NOT PREVIOUSLY EXIST, BEING THE SAME PROPERTY CONVEYED BY HENRY M. FLAGLER TO FLORIDA EAST COAST HOTEL COMPANY, BY DEED DATED MARCH 15, 1898, AND RECORDED IN DEED BOOK No. 1, PAGES 421, 422 AND 423 OF THE PUBLIC RECORDS OF ST. JOHNS COUNTY, FLORIDA, AND ALSO DESCRIBED AS LOT NINETEEN (19), BLOCK 38-A, CITY OF ST. AUGUSTINE, FLORIDA, ACCORDING TO OFFICIAL MAP THEREOF RECORDED IN THE OFFICE OF THE CLERK OF THE CIRCUIT COURT IN AND FOR ST. JOHNS COUNTY, FLORIDA.

**LEGEND**

- R/W = RIGHT OF WAY
- CONC = CONCRETE
- (R) = RECORD
- (M) = MEASURED
- WDF = WOOD FENCE
- CLF = CHAIN LINK FENCE
- OHW = OVERHEAD WIRE
- PP = POWER POLE
- WM = WATER METER
- = FOUND 1/2" IRON PIPE - NO IDENTIFICATION
- ⊙ = SET 5/8" IRON ROD - LB # 7111
- = NAIL AND DISK FOUND - NO IDENTIFICATION
- ⊗ = FOUND 3/4" IRON PIPE - NO IDENTIFICATION
- 1st Fl = FIRST FLOOR
- 2nd Fl = SECOND FLOOR

**NOTES**

- THE PARCEL OF LAND AS SHOWN HEREON LIES WITHIN FEDERAL FLOOD ZONE "A-E" ( ELEVATION 9 FEET ) AS DEPICTED ON FLOOD INSURANCE RATE MAP COMMUNITY PANEL NO. 125145-0314-G FOR THE CITY OF ST. AUGUSTINE, FLORIDA AS REVISED 09/03/03.
- THE TWO STORY BUILDING WILL CONTAIN RESIDENTIAL CONDOMINIUM UNITS. THE WOOD BUILDING IS USED FOR STORAGE.
- THE RESIDENTIAL CONDOMINIUM BUILDING IS APPROXIMATELY 29 FEET IN HEIGHT
- THE STORAGE BUILDING IS APPROXIMATELY 14 FEET IN HEIGHT.
- ALL AREAS EXCLUSIVE OF THE CONDOMINIUM UNITS ARE COMMON ELEMENTS.
- STAIRWAYS, PORCHES AND LANDINGS ARE LIMITED COMMON ELEMENTS.
- ALL IMPROVEMENTS ARE EXISTING.
- THE BASIS OF BEARING AS SHOWN HEREON IS THE WEST RIGHT-OF-WAY LINE OF CORDOVA STREET WHOSE ASSUMED BEARING BEARS N 20°30'00" W.
- OWNERSHIP OF FENCES NOT DETERMINED BY THIS SURVEY.
- ALL ELEVATIONS AS SHOWN HEREON ARE BASED ON NATIONAL GEODETIC VERTICAL DATUM OF 1929 ( N.G.V.D. - 1929 ).
- ALL CALCULATED DATA IS BASED ON FIELD MEASUREMENT.
- ENCROACHMENTS AS SHOWN HEREON ARE ONLY THOSE ABOVEGROUND, VISIBLE OBJECTS OBSERVED BY THE SURVEYOR.
- THIS SURVEY DOES NOT REFLECT OR DETERMINE OWNERSHIP.
- NO UNDERGROUND STRUCTURES, UTILITIES OR FOUNDATIONS WERE LOCATED OR DETERMINED BY THIS SURVEY.
- THE PARCEL OF LAND AS SHOWN HEREON WAS NOT ABSTRACTED FOR DEEDS, DEED RESTRICTIONS, EASEMENTS OR RIGHTS OF WAY OF RECORD.
- THIS SURVEY IS NOT VALID UNLESS IT IS SIGNED AND EMBOSSED WITH THE SIGNING SURVEYORS SEAL.
- THIS SURVEY IS CERTIFIED TO AND FOR THE USE AND BENEFIT OF: LAKEVIEW CONDOS, LLC; UPCHURCH, BAILEY AND UPCHURCH, P.A.; ATTORNEYS TITLE INSURANCE FUND, INC.
- SUBJECT TO THE ABOVE CONDITIONS AND RESTRICTIONS I HEREBY CERTIFY THAT THE SURVEY SHOWN HEREON WAS PERFORMED BY EITHER MYSELF OR UNDER MY DIRECT SUPERVISION AND THAT ALL OF THE INFORMATION SHOWN HEREON IS TRUE AND CORRECT TO THE BEST OF MY KNOWLEDGE AND BELIEF AND THAT THIS SURVEY CONFORMS TO SECTION 472.027 OF THE FLORIDA STATUTES AS AMENDED, AND 61G17-6 OF THE FLORIDA ADMINISTRATIVE CODE.

FIELD BOOK: 175/75-76  
 FIELD WORK: 01/20/05  
 SCALE: 1" = 80'  
 JOB NO.: 4-468  
 TYPE SURVEY: BOUNDARY

ANCIENT CITY SURVEYING, L.P. 7111  
 633 US-1 SOUTH  
 ST. AUGUSTINE, FLORIDA 32086  
 (904) 707-9987  
  
 MICHAEL A. PIRSICH, SLS # 1203

EXHIBIT "A"

# LAKE VIEW CONDOMINIUM EXISTING FLOOR PLAN

SHEET 4 OF 23

## FIRST FLOOR

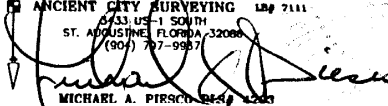
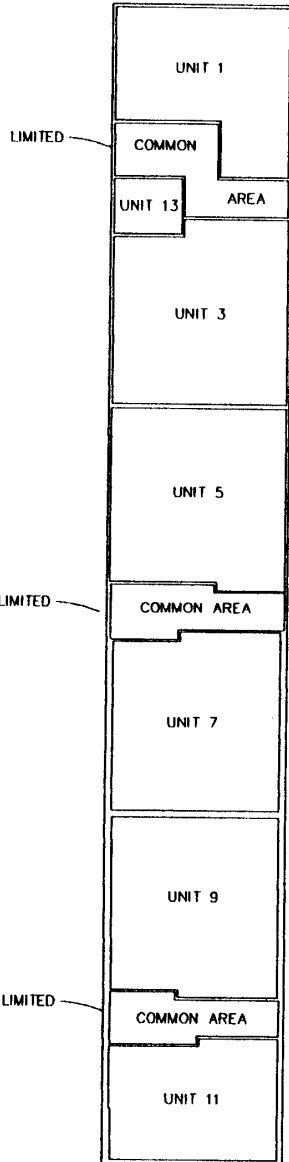

## SECOND FLOOR

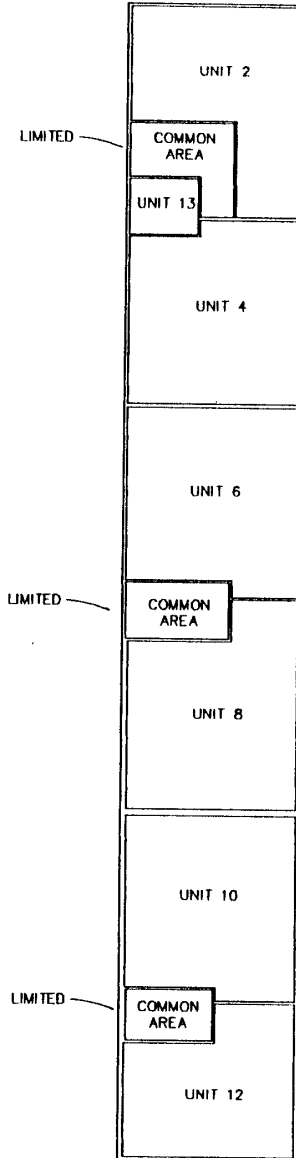

DATE OF SURVEY 01/19/2005



SCALE: 1 INCH = 30 FEET



PREPARED BY:  
**ANCIENT CITY SURVEYING** LB# 7111  
 3433 US-1 SOUTH  
 ST. AUGUSTINE, FLORIDA 32086  
 (904) 797-9967

0:\2005\4-688\dwg\4-688.dwg 01/20/05 11:22:51 AM EST

EXHIBIT "A"

# LAKEVIEW CONDOMINIUM

SHEET 5 OF 23

## UNIT #1

763 Square Feet

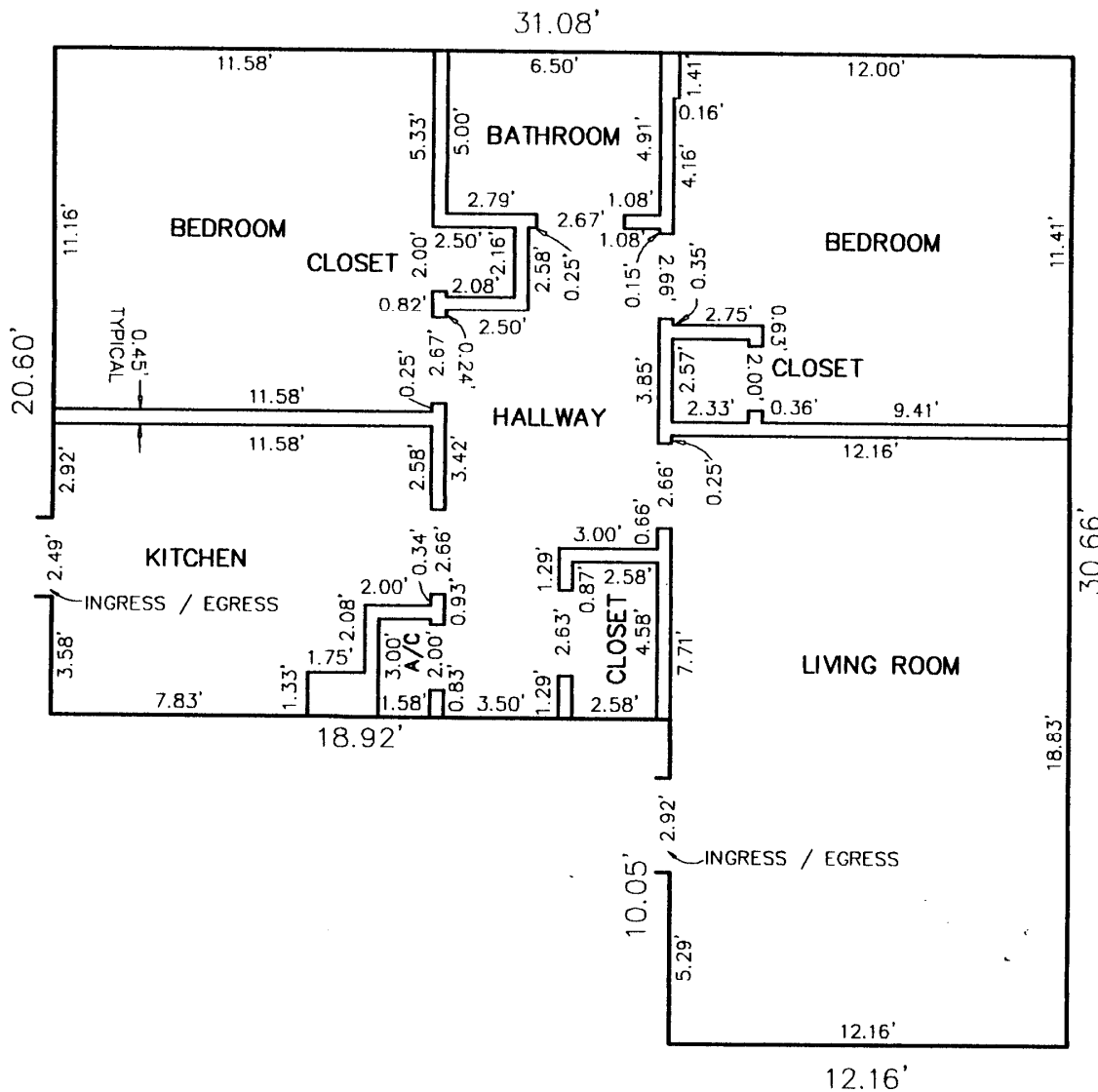

DATE OF SURVEY 01/19/2005



SCALE: 1 INCH = 5 FEET



PREPARED BY:  
**ANCIENT CITY SURVEYING** LB# 7111  
 3433 US-1 SOUTH  
 ST. AUGUSTINE, FLORIDA 32086  
 (904) 797-9967

EXHIBIT "A"

# LAKEVIEW CONDOMINIUM

SHEET 6 OF 23

## UNIT #2

856 Square Feet

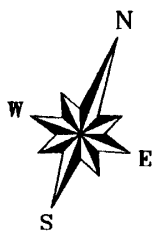
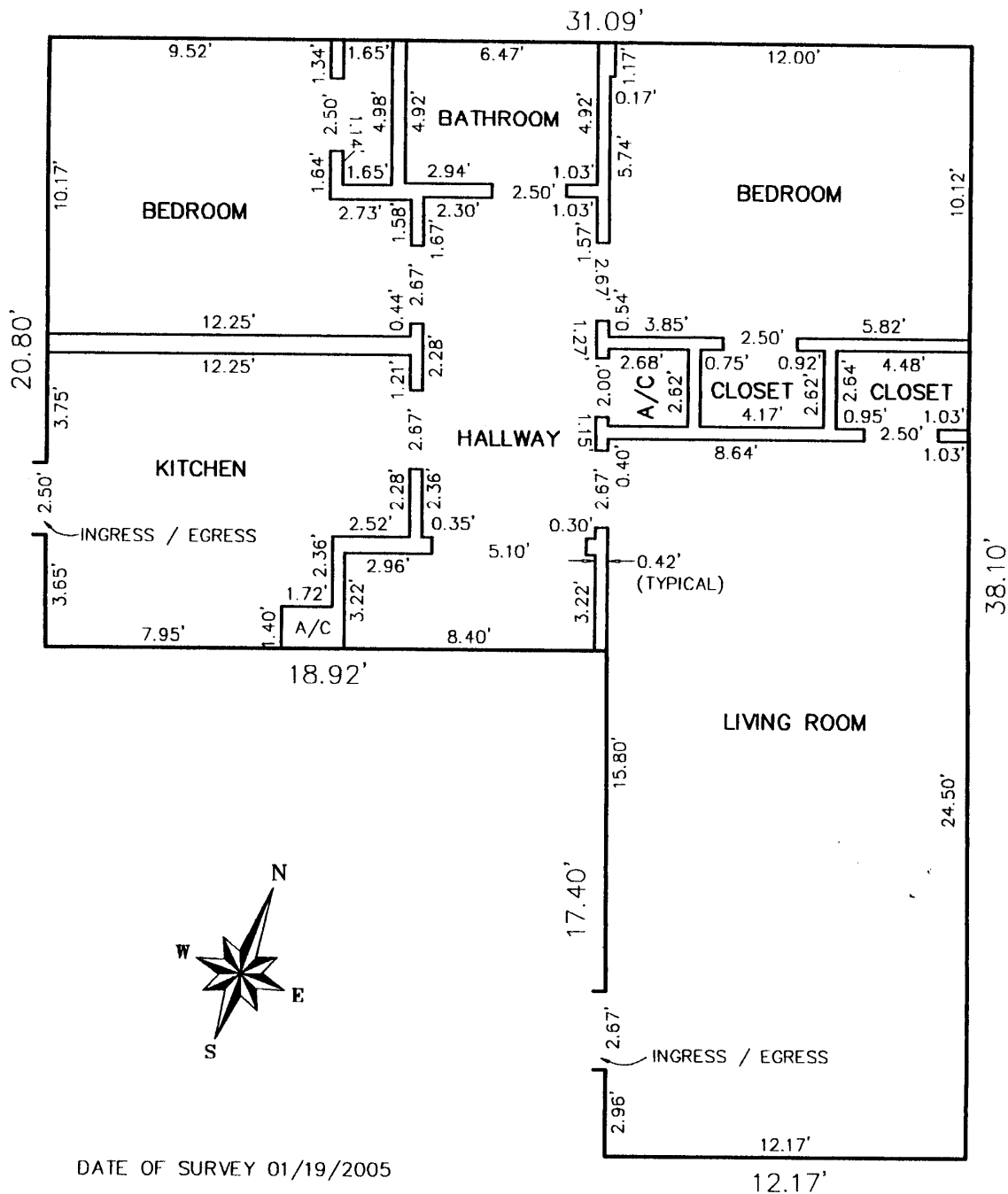

DATE OF SURVEY 01/19/2005



SCALE: 1 INCH = 5 FEET

PREPARED BY:  
**ANCIENT CITY SURVEYING** LB# 7111  
 3433 US-1 SOUTH  
 ST. AUGUSTINE, FLORIDA 32086  
 (904) 797-9967



EXHIBIT "A"

# LAKEVIEW CONDOMINIUM

SHEET 7 OF 23

## UNIT #3

1,005 Square Feet

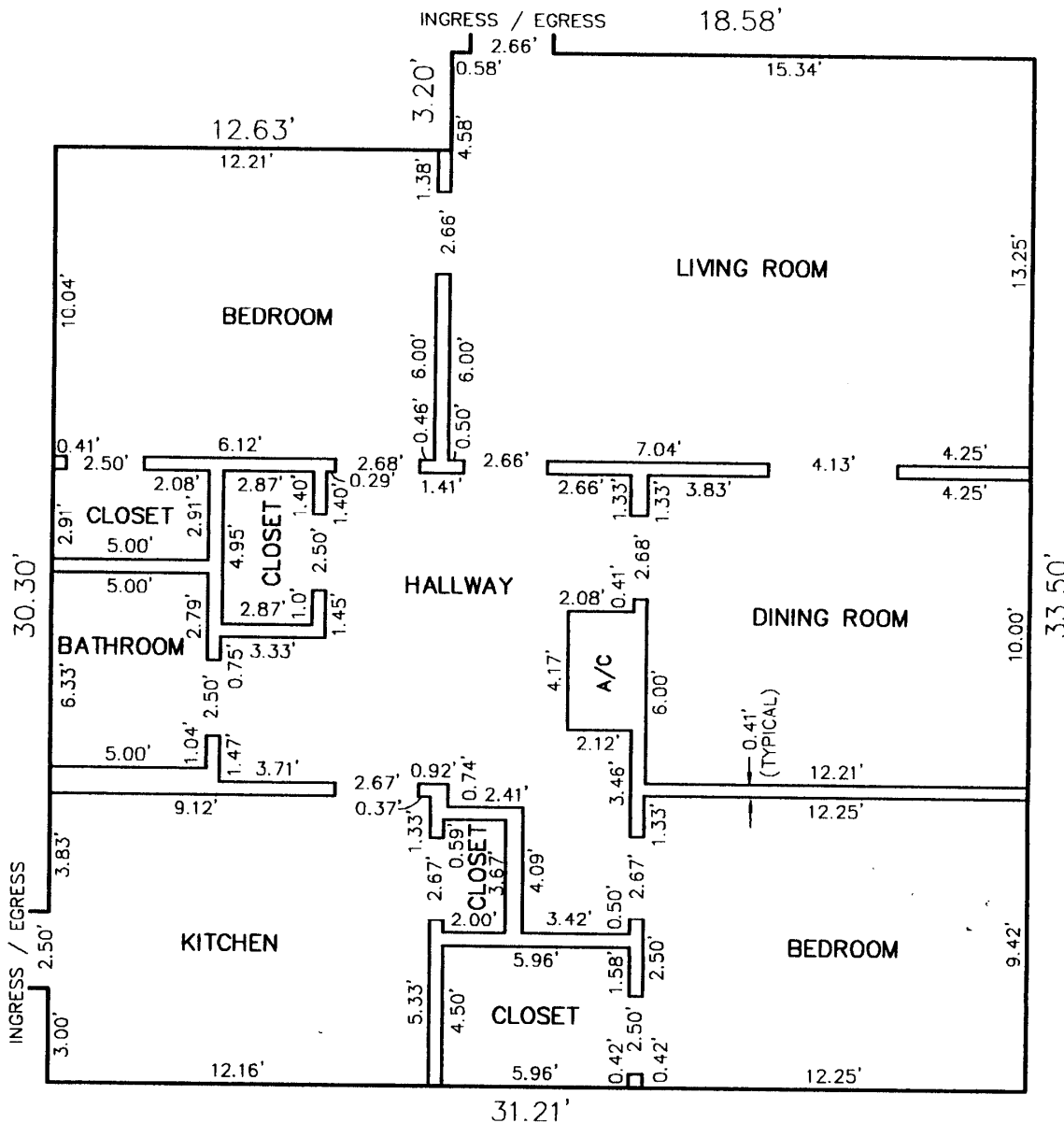

DATE OF SURVEY 01/19/2005



SCALE: 1 INCH = 5 FEET



PREPARED BY:  
**ANCIENT CITY SURVEYING** LB# 7111  
 3433 US-1 SOUTH  
 ST. AUGUSTINE, FLORIDA 32086  
 (904) 797-9967

EXHIBIT "A"

# LAKEVIEW CONDOMINIUM

SHEET 8 OF 23

## UNIT #4

1,001 Square Feet

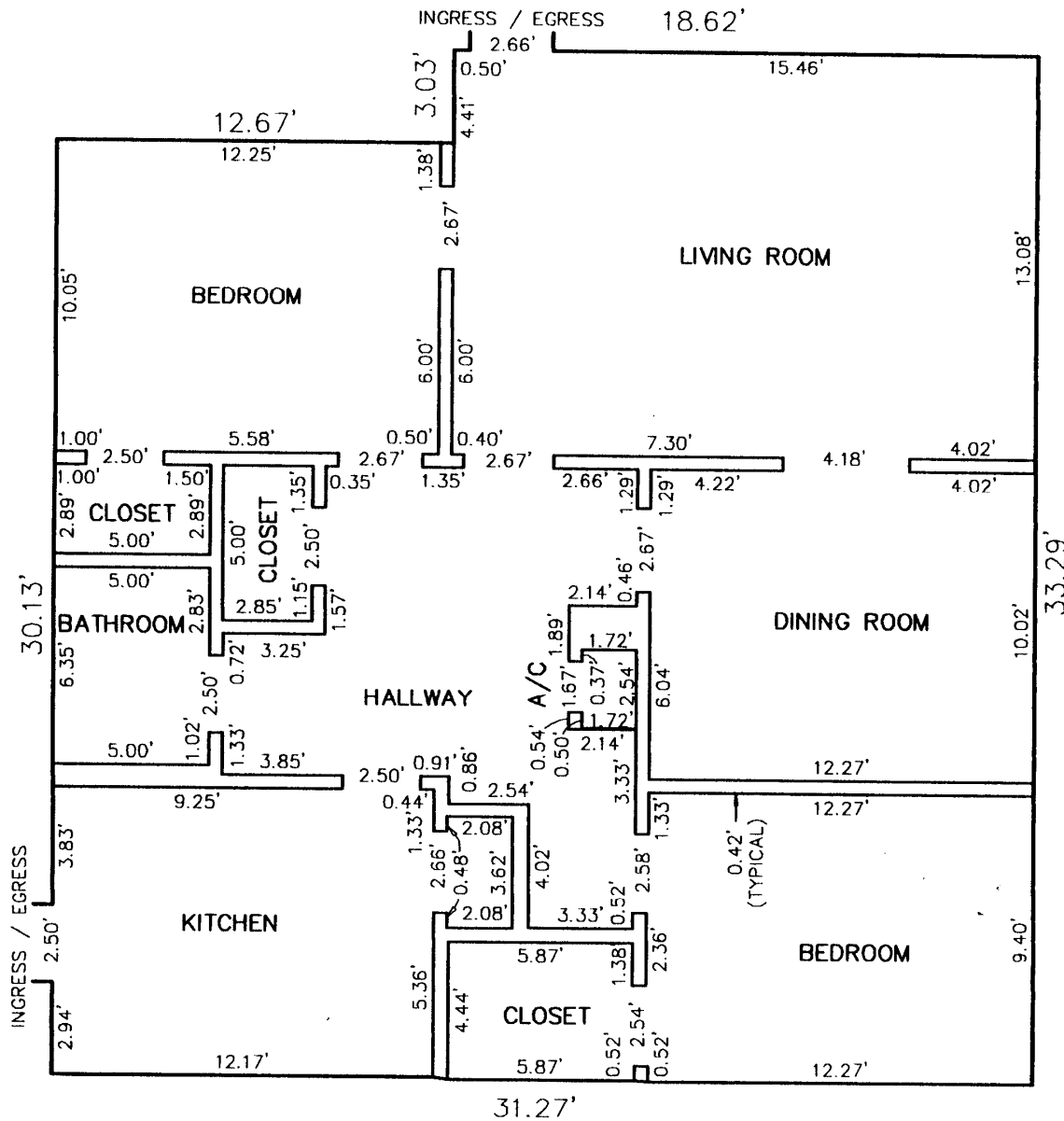

DATE OF SURVEY 01/19/2005



SCALE: 1 INCH = 5 FEET



PREPARED BY:  
**ANCIENT CITY SURVEYING** L&P 7111  
 3433 US-1 SOUTH  
 ST. AUGUSTINE, FLORIDA 32086  
 (904) 797-9967





EXHIBIT "A"

# LAKEVIEW CONDOMINIUM

SHEET 11 OF 23

## UNIT #7

939 Square Feet

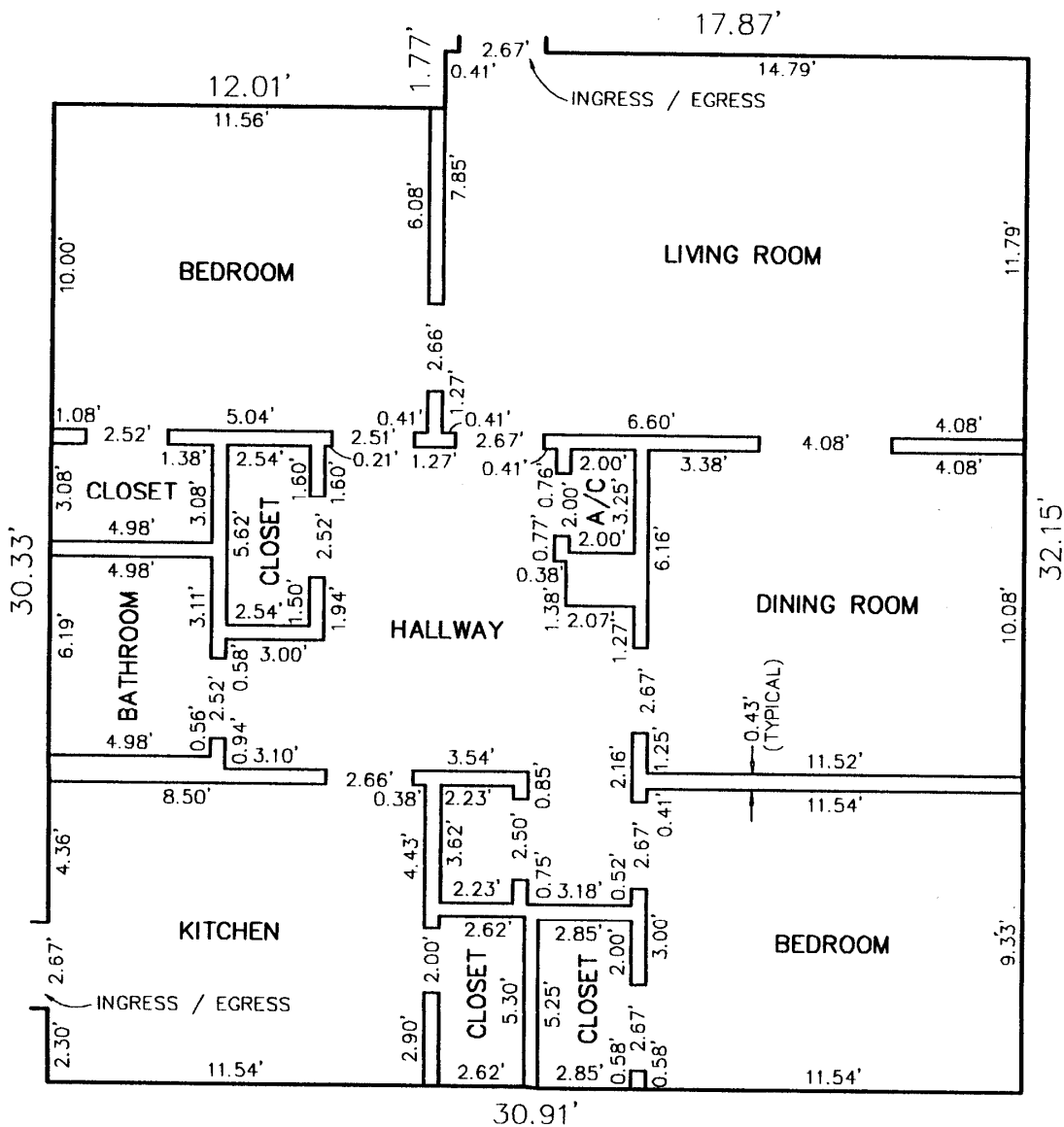

DATE OF SURVEY 01/19/2005



SCALE: 1 INCH = 5 FEET



PREPARED BY:  
**ANCIENT CITY SURVEYING** LB# 7111  
 3433 US-1 SOUTH  
 ST. AUGUSTINE, FLORIDA 32086  
 (904) 797-9967

EXHIBIT "A"

# LAKEVIEW CONDOMINIUM

SHEET 12 OF 23

## UNIT #8

1,013 Square Feet

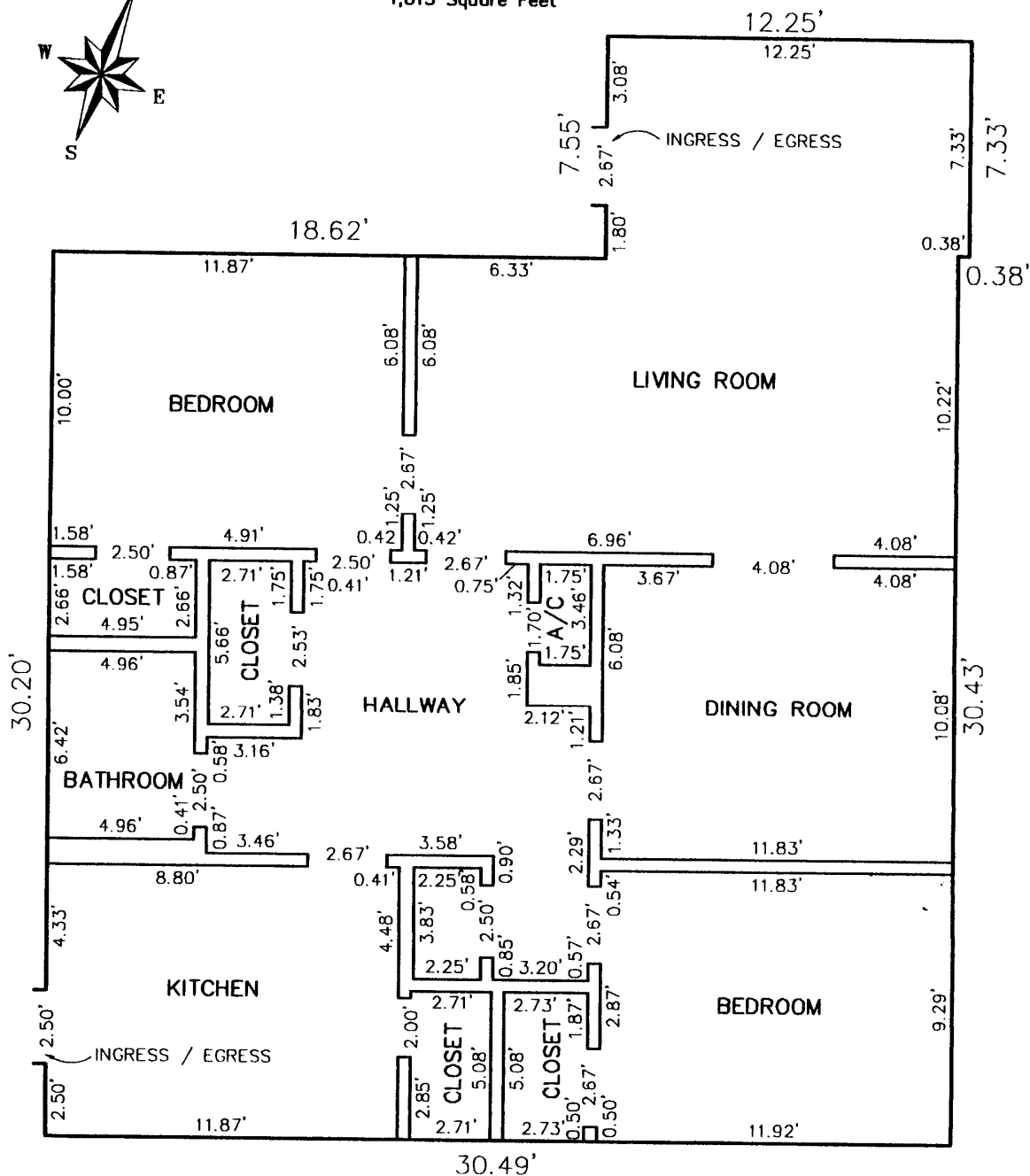

DATE OF SURVEY 01/19/2005



SCALE: 1 INCH = 5 FEET



PREPARED BY:  
**ANCIENT CITY SURVEYING** LB# 7111  
 3433 US-1 SOUTH  
 ST. AUGUSTINE, FLORIDA 32086  
 (904) 797-9967

EXHIBIT "A"

# LAKEVIEW CONDOMINIUM

SHEET 13 OF 23

## UNIT #9

961 Square Feet

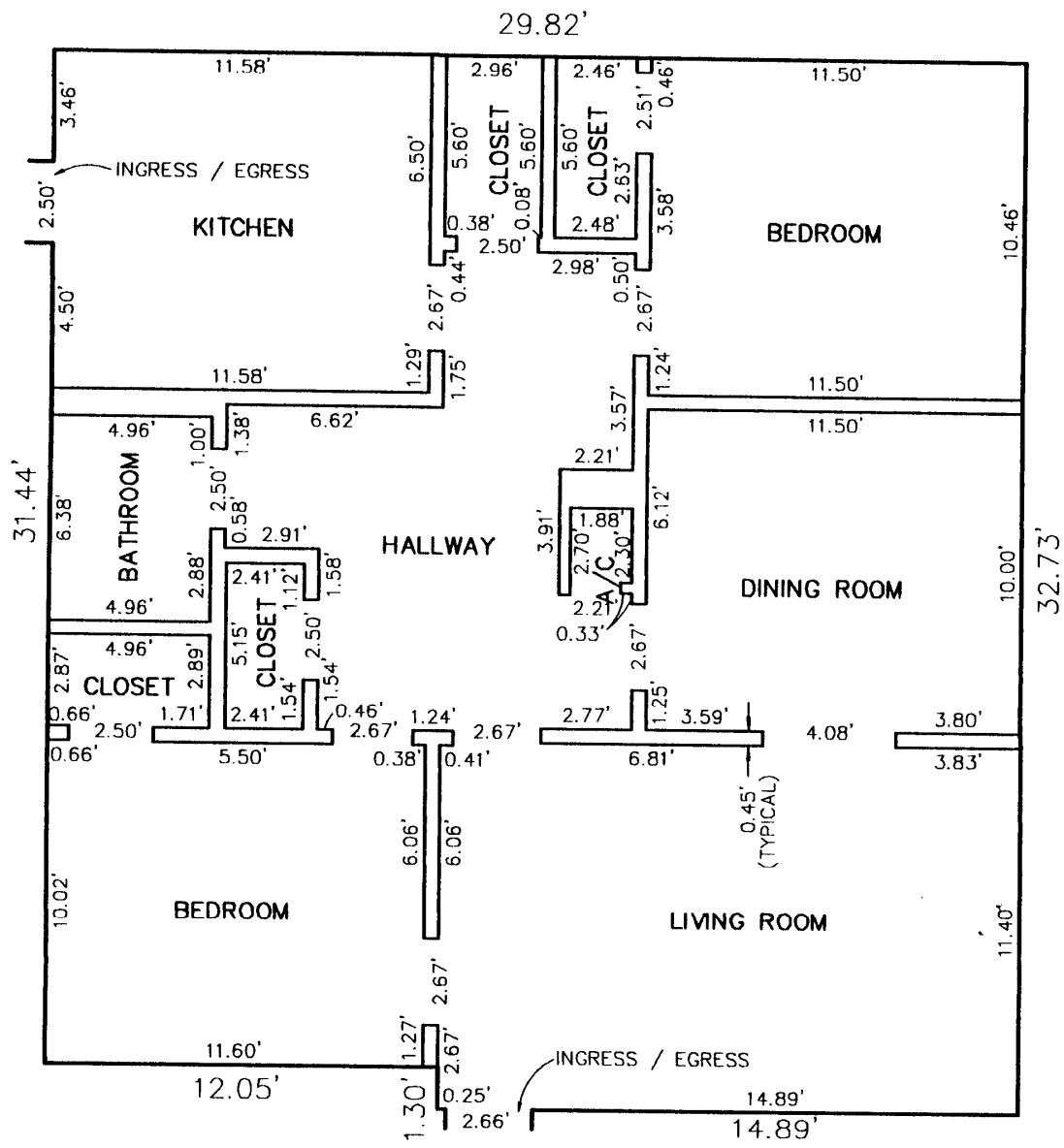

DATE OF SURVEY 01/19/2005



SCALE: 1 INCH = 5 FEET



PREPARED BY:  
**ANCIENT CITY SURVEYING** LB# 7111  
 3433 US-1 SOUTH  
 ST. AUGUSTINE, FLORIDA 32086  
 (904) 797-9967

EXHIBIT "A"

# LAKEVIEW CONDOMINIUM

SHEET 14 OF 23

## UNIT #10

989 Square Feet

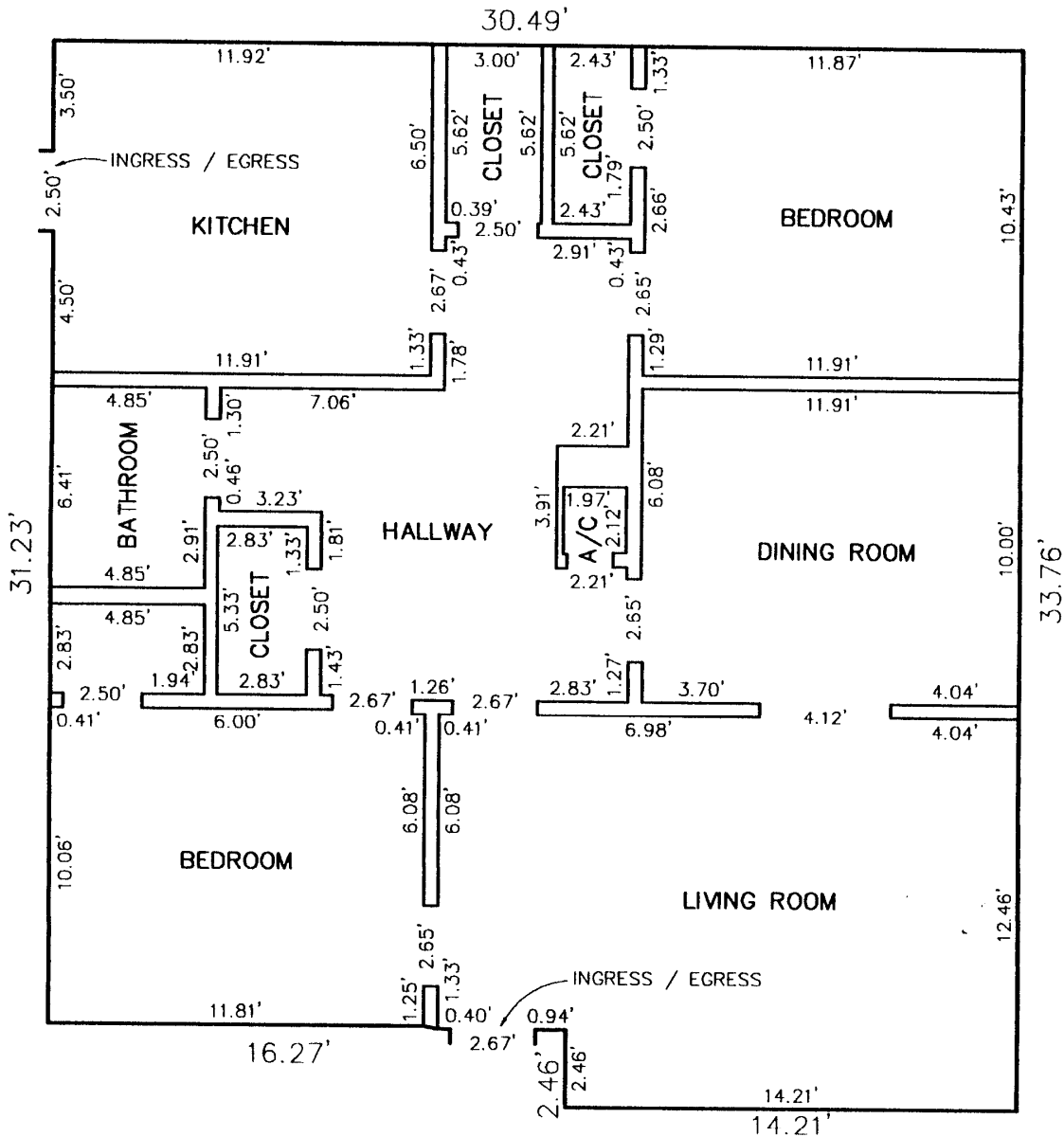

DATE OF SURVEY 01/19/2005



SCALE: 1 INCH = 5 FEET



PREPARED BY:  
**ANCIENT CITY SURVEYING** LB# 7111  
 3433 US-1 SOUTH  
 ST. AUGUSTINE, FLORIDA 32086  
 (904) 797-9967



EXHIBIT "A"

# LAKEVIEW CONDOMINIUM

SHEET 15 OF 23

## UNIT #11

635 Square Feet

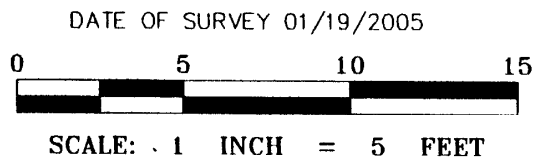
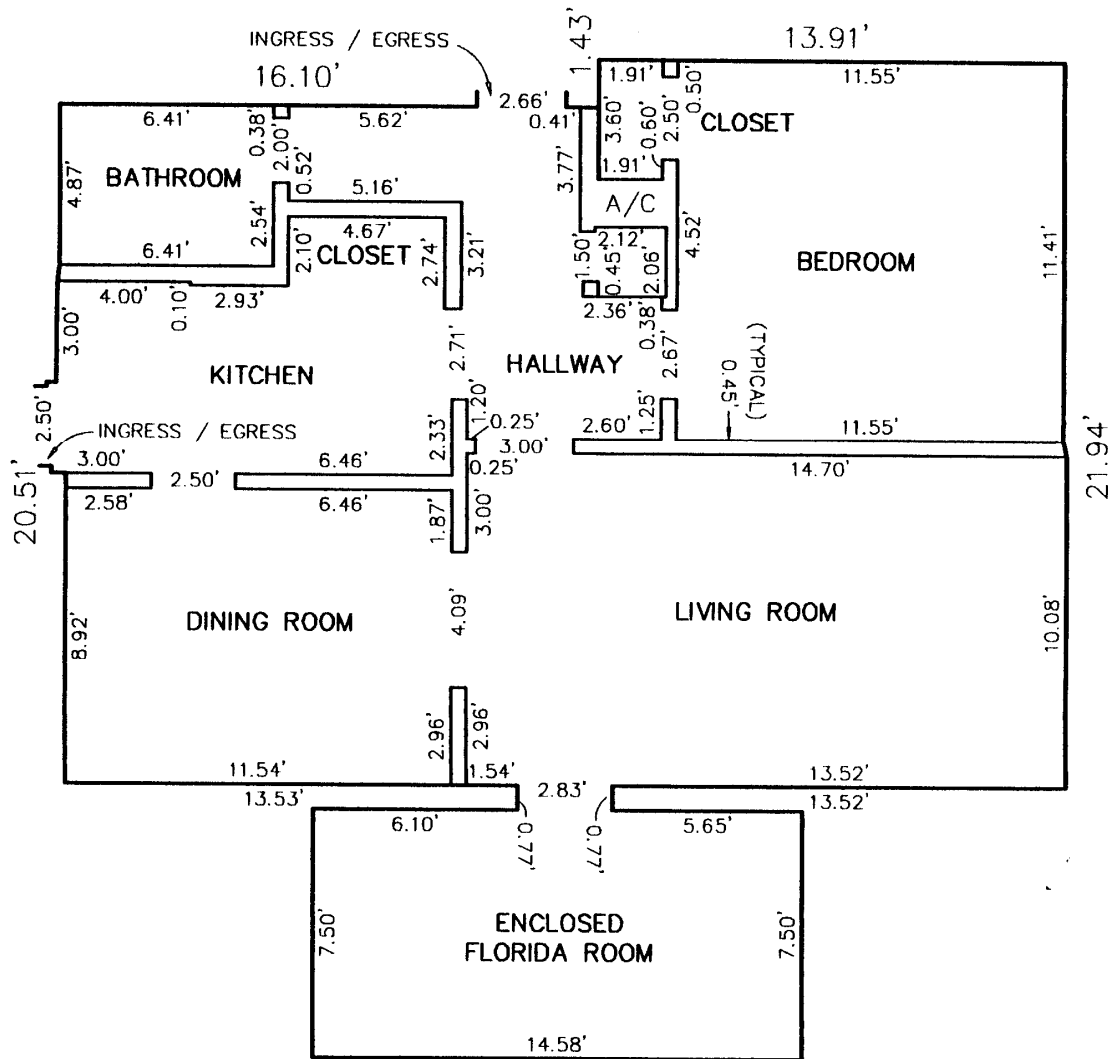

PREPARED BY:  
**ANCIENT CITY SURVEYING** LB# 7111  
 3433 US-1 SOUTH  
 ST. AUGUSTINE, FLORIDA 32086  
 (904) 797-9967

EXHIBIT "A"

# LAKEVIEW CONDOMINIUM

SHEET 16 OF 23

## UNIT #12

735 Square feet

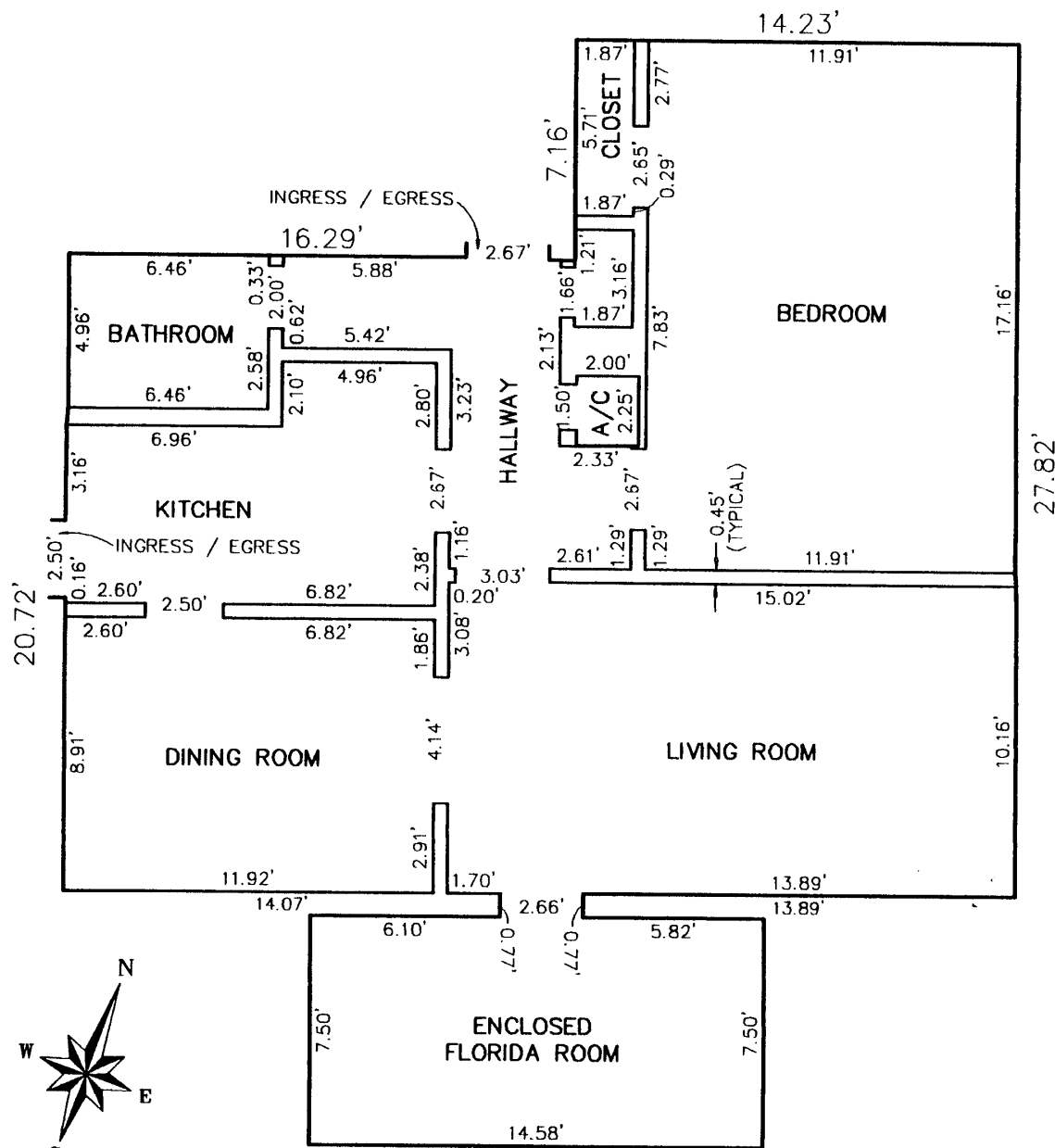

DATE OF SURVEY 01/19/2005



SCALE: 1 INCH = 5 FEET



PREPARED BY:  
**ANCIENT CITY SURVEYING** LB# 7111  
 3433 US-1 SOUTH  
 ST. AUGUSTINE, FLORIDA 32086  
 (904) 797-9967

EXHIBIT "A"

SHEET 17 OF 23

# LAKEVIEW CONDOMINIUM UNIT 13 (FIRST FLOOR) AND LIMITED COMMON AREA

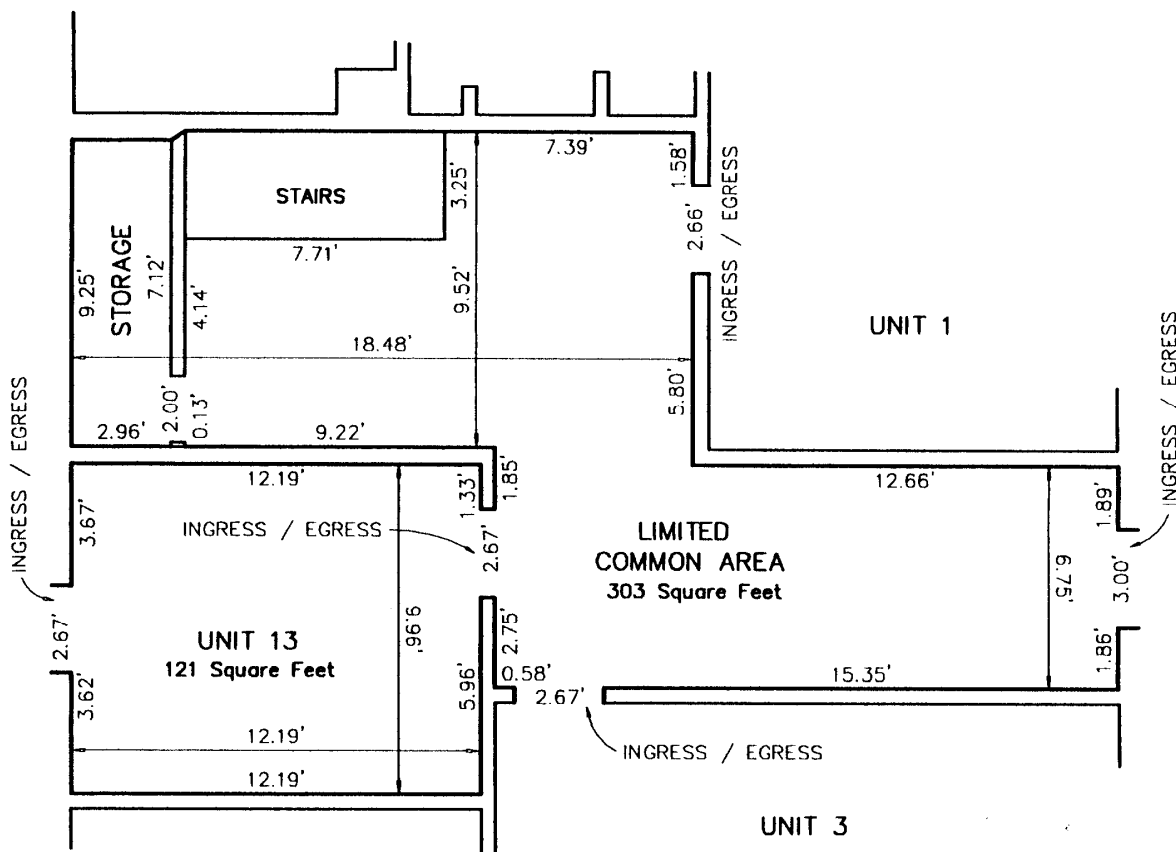

DATE OF SURVEY 01/19/2005



SCALE: 1 INCH = 5 FEET



PREPARED BY:  
**ANCIENT CITY SURVEYING** LB# 7111  
 3433 US-1 SOUTH  
 ST. AUGUSTINE, FLORIDA 32086  
 (904) 797-9967

EXHIBIT "A"

SHEET 18 OF 23

# LAKEVIEW CONDOMINIUM UNIT 13 (SECOND FLOOR) AND LIMITED COMMON AREA

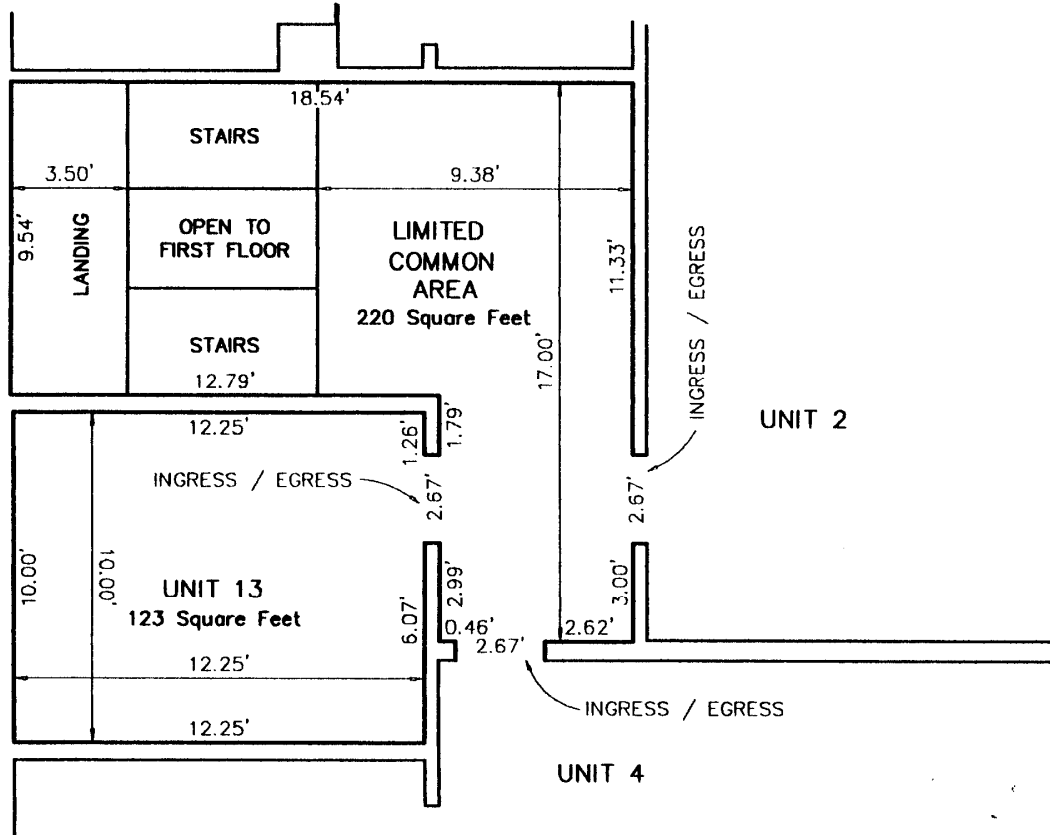

DATE OF SURVEY 01/19/2005



SCALE: 1 INCH = 5 FEET



PREPARED BY:  
**ANCIENT CITY SURVEYING** LBS# 7111  
 3433 US-1 SOUTH  
 ST. AUGUSTINE, FLORIDA 32086  
 (904) 797-9967

EXHIBIT "A"

# LAKEVIEW CONDOMINIUM COMMON AREA

SHEET 19 OF 23

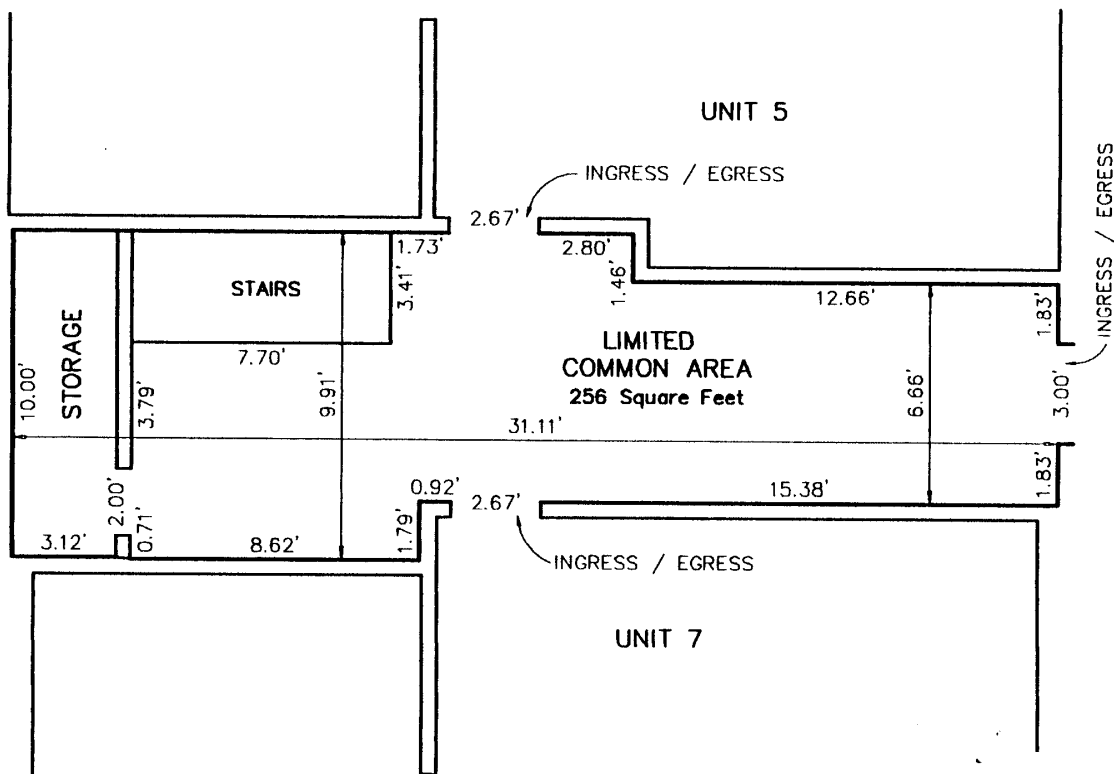

DATE OF SURVEY 01/19/2005

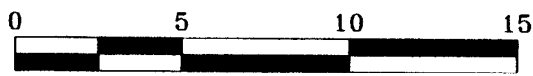

SCALE: 1 INCH = 5 FEET



PREPARED BY:  
**ANCIENT CITY SURVEYING** LBY 7111  
 3433 US-1 SOUTH  
 ST. AUGUSTINE, FLORIDA 32086  
 (904) 797-9967

EXHIBIT "A"

# LAKE VIEW CONDOMINIUM COMMON AREA

SHEET 20 OF 23

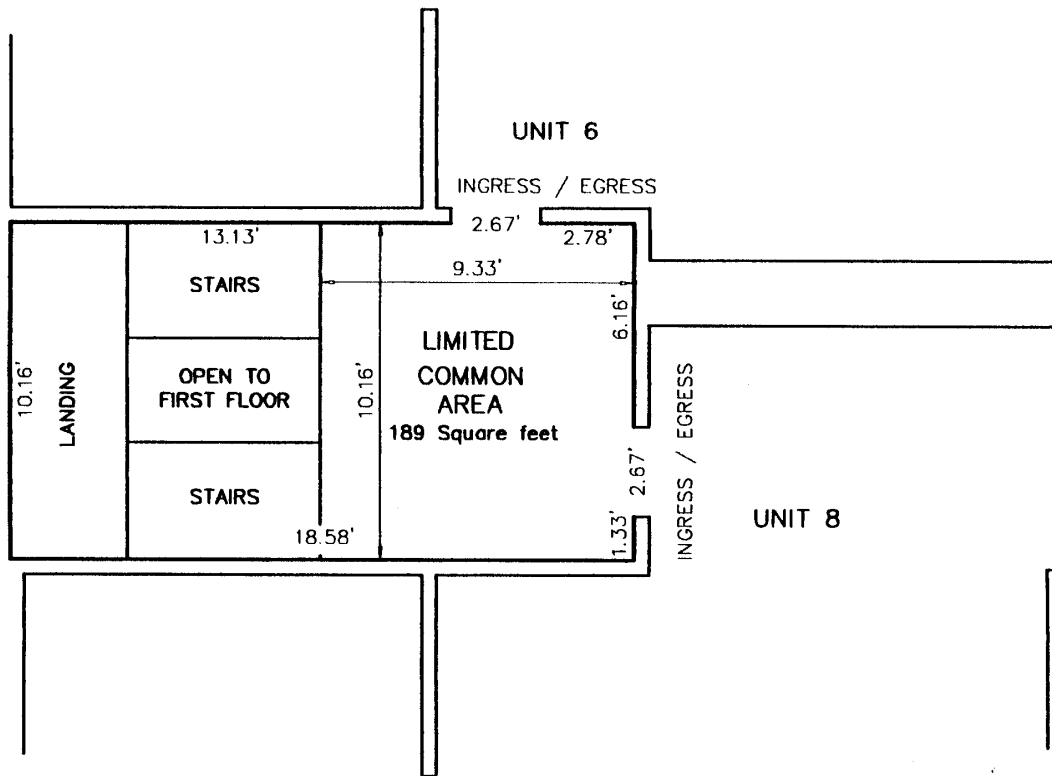

DATE OF SURVEY 01/19/2005



SCALE: 1 INCH = 5 FEET



PREPARED BY:  
**ANCIENT CITY SURVEYING** LB# 7111  
 3433 US-1 SOUTH  
 ST. AUGUSTINE, FLORIDA 32086  
 (904) 797-9967

EXHIBIT "A"

# LAKEVIEW CONDOMINIUM COMMON AREA

SHEET 21 OF 23

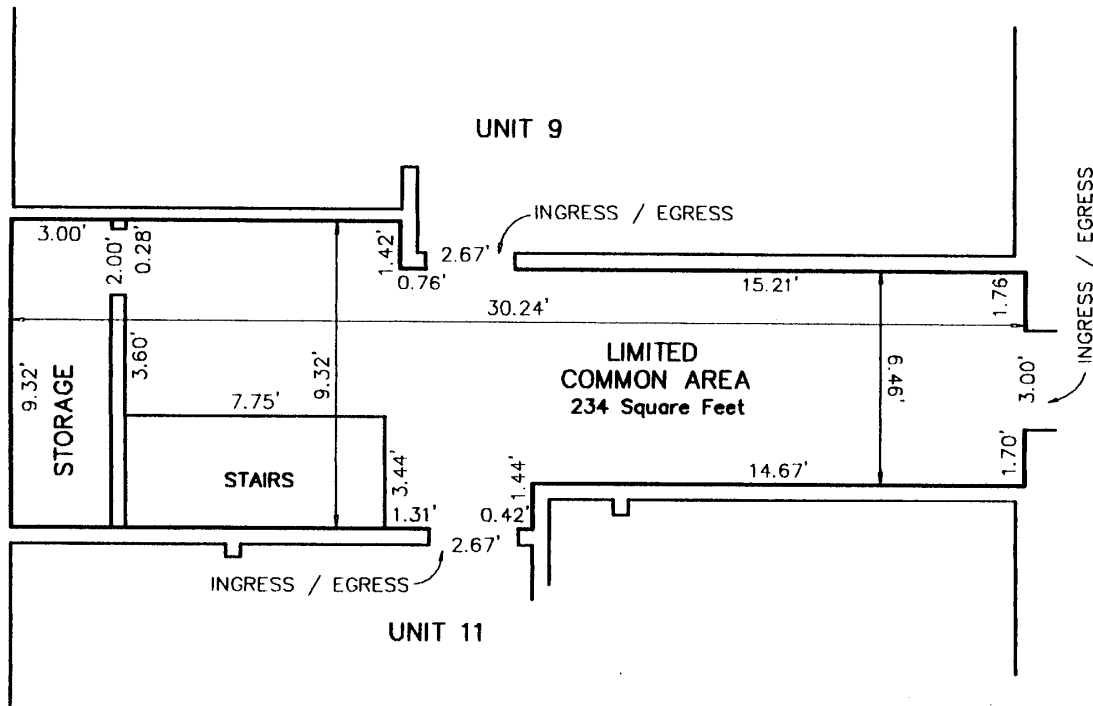

DATE OF SURVEY 01/19/2005



SCALE: 1 INCH = 5 FEET



PREPARED BY:  
ANCIENT CITY SURVEYING LB# 7111  
3433 US-1 SOUTH  
ST. AUGUSTINE, FLORIDA 32086  
(904) 797-9967

EXHIBIT "A"

# LAKEVIEW CONDOMINIUM COMMON AREA

SHEET 22 OF 23

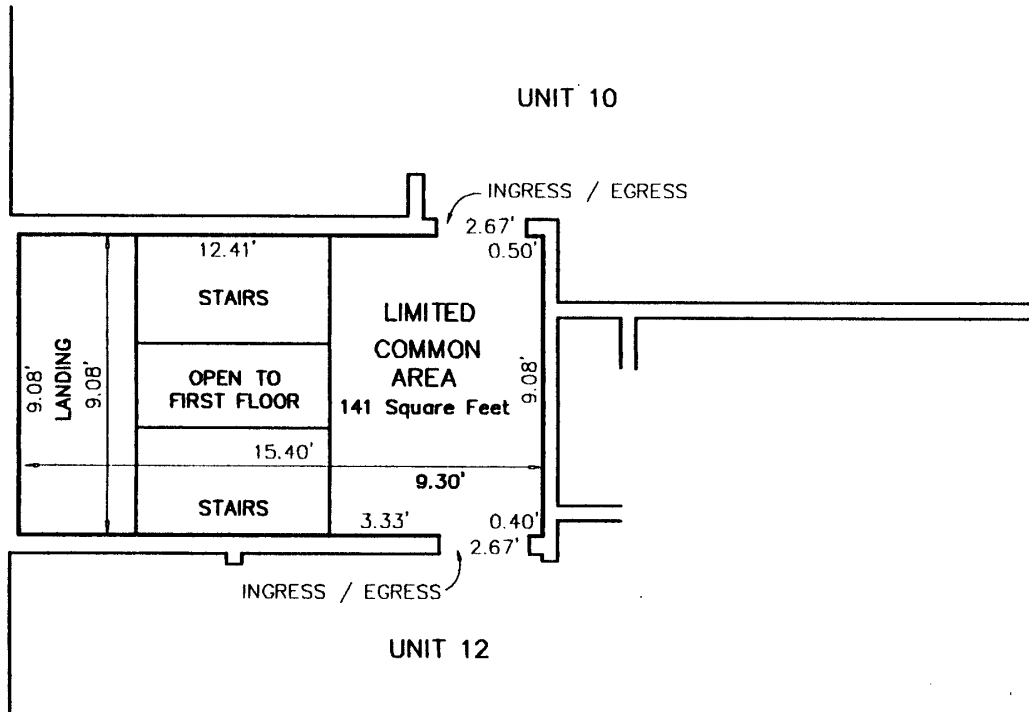

DATE OF SURVEY 01/19/2005



SCALE: 1 INCH = 5 FEET



PREPARED BY:  
**ANCIENT CITY SURVEYING** LBJ 7111  
 3433 US-1 SOUTH  
 ST. AUGUSTINE, FLORIDA 32086  
 (904) 797-9967



EXHIBIT "A"

# LAKEVIEW CONDOMINIUM EXISTING ELEVATIONS

SHEET 23 OF 23

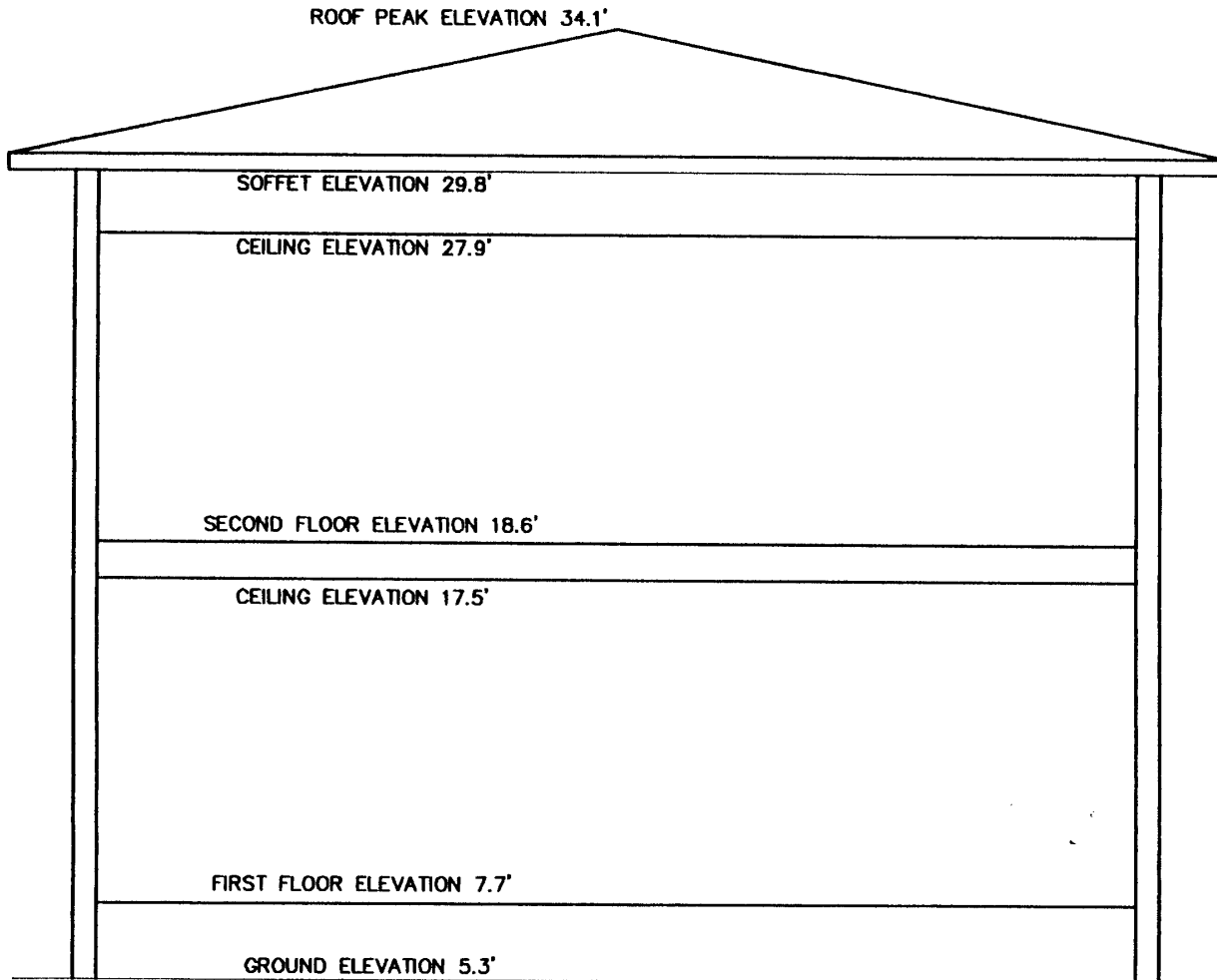

NOTE: ELEVATIONS AS SHOWN HEREON ARE REFERENCED TO THE NATIONAL GEODETIC VERTICAL DATUM OF 1929.

DATE OF SURVEY 01/19/2005



SCALE: 1 INCH = 5 FEET



PREPARED BY:  
ANCIENT CITY SURVEYING LBS 7111  
3433 US-1 SOUTH  
ST. AUGUSTINE, FLORIDA 32086  
(904) 797-9967

**EXHIBIT "D"**

**Articles of Incorporation**

**Of**

**Lakeview of St. Augustine Condominium Association, Inc.**

# State of Florida



## Department of State

I certify from the records of this office that LAKEVIEW OF ST. AUGUSTINE CONDOMINIUM ASSOCIATION, INC. is a corporation organized under the laws of the State of Florida, filed on April 20, 2005.

The document number of this corporation is N05000004073.

I further certify that said corporation has paid all fees due this office through December 31, 2005, and its status is active.

I further certify that said corporation has not filed Articles of Dissolution.

I further certify that this is an electronically transmitted certificate authorized by section 15.16, Florida Statutes, and authenticated by the code, 205A00027391-042105-N05000004073-1/1, noted below.

Authentication Code: 205A00027391-042105-N05000004073-1/1

Given under my hand and the Great Seal of the State of Florida, at Tallahassee, the Capital, this the Twenty-first day of April, 2005



*Glenda E. Hood*  
Glenda E. Hood  
Secretary of State

# State of Florida



## Department of State

I certify the attached is a true and correct copy of the Articles of Incorporation of LAKEVIEW OF ST. AUGUSTINE CONDOMINIUM ASSOCIATION, INC., a Florida corporation, filed on April 20, 2005, as shown by the records of this office.

I further certify the document was electronically received under FAX audit number H05000097731. This certificate is issued in accordance with section 15.16, Florida Statutes, and authenticated by the code noted below.

The document number of this corporation is N05000004073.

Authentication Code: 205A00027391-042105-N05000004073-1/1

Given under my hand and the Great Seal of the State of Florida, at Tallahassee, the Capital, this the Twenty-first day of April, 2005



*Glenda E. Hood*  
Glenda E. Hood  
Secretary of State



FLORIDA DEPARTMENT OF STATE

Glenda E. Hood  
Secretary of State

April 21, 2005

LAKEVIEW OF ST. AUGUSTINE CONDOMINIUM ASSOCIATION, INC.  
3942 A1A SOUTH  
ST. AUGUSTINE BEACH, FL 32080

The Articles of Incorporation for LAKEVIEW OF ST. AUGUSTINE CONDOMINIUM ASSOCIATION, INC. were filed on April 20, 2005, and assigned document number N05000004073. Please refer to this number whenever corresponding with this office.

Enclosed is the certification requested. To be official, the certification for a certified copy must be attached to the original document that was electronically submitted and filed under FAX audit number H05000097731.

A corporation annual report/uniform business report will be due this office between January 1 and May 1 of the year following the calendar year of the file/effective date year. A Federal Employer Identification (FEI) number will be required before this report can be filed. Please apply NOW with the Internal Revenue Service by calling 1-800-829-3676 and requesting form SS-4.

Please be aware if the corporate address changes, it is the responsibility of the corporation to notify this office.

Should you have questions regarding corporations, please contact this office at the address given below.

Claretha Golden  
Document Specialist  
New Filings Section  
Division of Corporations

Letter Number: 205A00027391

Division of Corporations - P.O. BOX 6327 -Tallahassee, Florida 32314

Audit # H05000097731 3

**ARTICLES OF INCORPORATION  
OF  
LAKEVIEW OF ST. AUGUSTINE  
CONDOMINIUM ASSOCIATION, INC.**

I, the undersigned natural person competent to contract, associate myself for the purpose of forming a corporation not-for-profit under Chapter 617, Florida Statutes (2004), and certify as follows:

**ARTICLE ONE: NAME**

The name of the corporation is Lakeview of St. Augustine Condominium Association, Inc. ("the Association").

**ARTICLE TWO: PURPOSE**

The purposes and objectives of the corporation are such as are authorized under the Florida Condominium Act, Chapter 718, Florida Statutes (2004), and the Florida Corporation Not-for-Profit Act, Chapter 617, Florida Statutes (2004), as they may be amended from time to time, and include providing for the operation, maintenance, preservation, administration, and management of Lakeview Condominium located in St. Augustine, St. Johns County, Florida ("the Condominium"), and the property of the Association ("the Property").

**ARTICLE THREE: POWERS**

In addition to the general powers afforded a corporation not-for-profit under the laws of the State of Florida, the Association shall have all the powers reasonably necessary to implement the purpose of this Association, including without limitation the following powers:

1. To operate and manage the Property, the Condominium, and the lands on which it is situated.
2. To carry out all the powers and duties vested in the Association pursuant to the Declaration of Condominium for Lakeview Condominium ("the Declaration of Condominium"), Bylaws, and any rules and regulations of the Association, which shall include without limitation:
  - a. to make and collect assessments against members to defray the costs, expenses and losses of the Association;
  - b. to use the proceeds of assessments in the exercise of its powers and duties;
  - c. to maintain, repair, replace and operate the Property;

Audit # H05000097731 3

- d. to reconstruct improvements after casualty and to further improve the Property;
- e. to make and amend regulations respecting the use of the Property;
- f. to enforce by legal means the provisions of the Declaration of Condominium, these Articles, the Bylaws of the Association and the rules and regulations for the use of the Property promulgated by the Board of Administration from time to time (“the Rules and Regulations”);
- g. to contract for the management and maintenance of the Condominium and to authorize a management agent to assist the Association in carrying out its powers and duties by performing such functions as the collection of assessments, preparation of records, enforcement of rules, and maintenance of the common elements. The Association shall, however, retain at all times the powers and duties granted it by the Condominium Act, including, but not limited to, the making of assessments, promulgation of rules and execution of contracts on behalf of the Association;
- h. to purchase insurance upon the Property and insurance for the protection of the Association and its members as Unit Owners;
- i. to acquire title to property or otherwise hold, convey, lease and mortgage Association property for the use and benefit of its members.

3. The Association shall be authorized to exercise and enjoy all the powers, rights and privileges granted to or conferred upon nonprofit corporations of a similar character by the provisions of Chapter 617, Florida Statutes (2004), and as may be amended from time to time to do any and all things necessary to carry out its purposes.

4. The Association shall be authorized to exercise and enjoy all the powers, rights and privileges granted to or conferred upon corporations formed to operate condominiums under the provisions of Chapter 718, Florida Statutes (2004), and as may be amended from time to time.

5. No compensation shall be paid to Directors for their services as Directors. However, compensation may be paid to a Director in his or her capacity as an employee or for other services rendered to the Association outside of his or her duties as a Director. In such case, compensation must be approved by the other members of the Board. The Directors shall have the right to set and pay all salaries or compensation to be paid to employees, agents, or attorneys for services rendered to the corporation.

6. All funds and the title to all property acquired by this Association and the proceeds thereof shall be held in trust for the owners of the Condominium Parcels in accordance with the provisions of the Declaration of Condominium, these Articles and the Bylaws.

Audit # H05000097731 3

7. All of the powers of this Association shall be subject to and shall be exercised in accordance with the provisions of the Declaration of Condominium and the Bylaws and Rules and Regulations.

**ARTICLE FOUR: MEMBERS**

Each Condominium Parcel shall have as an appurtenance thereto a membership or memberships in the Association, which shall be held by the Owner or Owners of the Condominium Parcel. No person or entity holding title to a Condominium Parcel as security for the performance of an obligation, shall acquire the membership appurtenant to such Condominium Parcel by virtue of such title ownership. In no event may any membership be severed from the Condominium Parcel to which it is appurtenant. The voting rights of members are set forth in the Bylaws and Declaration.

**ARTICLE FIVE: DURATION**

The period of the duration of the corporation is perpetual.

**ARTICLE SIX: SUBSCRIBER**

The name and address of the subscriber to these Articles is:

**Name**

**Address**

Curtis L. Farber

911-C Lomas Santa Fe Drive  
Solana Beach, California 92075

**ARTICLE SEVEN: OFFICERS**

The affairs of the corporation are to be managed by a President, Secretary, and Treasurer who will be accountable to the Board of Administration. The offices of Vice President, Secretary or Treasurer may be combined in one individual. Officers will be elected annually in the manner set forth in the Bylaws.

**ARTICLE EIGHT: DIRECTORS**

The number of persons constituting the first Board of Administration is not less than three (3). The number of directors may be increased or decreased from time to time as provided by the Bylaws, provided there shall never be less than three (3). The names and addresses of the directors who are to serve until the first annual meeting of the members or until their successors are elected and qualified are:

Audit # H05000097731 3



Audit # H05000097731 3

<u>Name</u>	<u>Address</u>
Curtis L. Farber	911-C Lomas Santa Fe Drive Solana Beach, California 92075
Stephanie Farber	911-C Lomas Santa Fe Drive Solana Beach, California 92075
Michelle Cummings	363-12 Atlantic Boulevard Atlantic Beach, Florida 32233

The election of Directors, their terms of office, removal or the filling of vacancies on said Board shall be in accordance with the Bylaws of the Association.

**ARTICLE NINE: BYLAWS**

Bylaws regulating operation of the corporation shall be adopted by the Board of Administration and may be amended by the first Board of Administration until the first annual meeting of members. Thereafter, the Bylaws shall be amended by the members in the manner set forth in the Bylaws.

**ARTICLE TEN: AMENDMENT**

Amendments to these Articles of Incorporation may be proposed by at least two-thirds (2/3) of the Directors or by members entitled to exercise at least one-third (1/3) of the then authorized membership voting power. Amendments may be adopted by affirmative vote of those members exercising not less than two-thirds (2/3) of the total voting power of the corporation. Additional requirements concerning proposal and adoption of amendments to these Articles shall be set forth in the Bylaws.

**ARTICLE ELEVEN: INDEMNIFICATION**

Every Director and officer of the Association and every member of the Association serving the Association at its request shall be indemnified by the Association against all expenses and liabilities, including attorneys' fees and appellate attorneys' fees, reasonably incurred by or imposed upon him or her in connection with any proceeding or any settlement of any proceeding to which he or she may be a party, or in which he or she may become involved by reason of his or her being or having been a director or officer of the Association, or by reason of his or her serving or having served the Association at its request, whether or not he or she is a director or officer or is serving at the time the expenses or liabilities are incurred; provided that, in the event of a settlement before entry of judgment, and also when the person concerned is adjudged guilty of gross negligence or willful misconduct in the performance of his or her duties, the indemnification shall apply only when the Board of Administration approves the

Audit # H05000097731 3

Audit # H05000097731 3

settlement and reimbursement as being for the best interests of the Association. The foregoing right of indemnification shall be in addition to and not in lieu of any and all other rights to which that person may be entitled.

**ARTICLE TWELVE: PRINCIPAL OFFICE, INITIAL REGISTERED OFFICE, AND REGISTERED AGENT**

The street and mailing address of the initial principal office of the Association is 3942 A1A South, St. Augustine Beach, Florida 32080. The street address of the initial registered office of the Association is 780 North Ponce de Leon Boulevard, St. Augustine, Florida 32084, and the name of its initial Registered Agent at such address is Katherine G. Jones.

**ARTICLE THIRTEEN: DEFINITIONS**

Capitalized terms not defined in these Articles shall have the meanings set forth in the Declaration and the Condominium Act.

  
\_\_\_\_\_  
Curtis L. Farber  
Subscriber/Incorporator

**ACCEPTANCE BY REGISTERED AGENT**

I am familiar with and accept the duties and responsibilities as Registered Agent for the foregoing corporation.

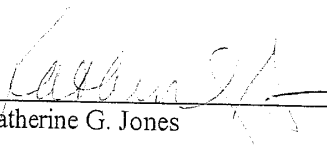
  
\_\_\_\_\_  
Katherine G. Jones

Audit # H05000097731 3

**EXHIBIT "E"**

**Bylaws of Lakeview of St. Augustine Condominium Association, Inc.**

**BY-LAWS OF  
LAKEVIEW OF ST. AUGUSTINE  
CONDOMINIUM ASSOCIATION, INC.**

**ARTICLE ONE: PLAN OF CONDOMINIUM OWNERSHIP**

**Section One. Creation of Condominium.** Lakeview Condominium, located at 172-180 Cordova Street, St. Augustine, Florida 32084, ("the Condominium") is submitted to the provisions of Chapter 718, Florida Statutes (2004), ("the Condominium Act"), by Declaration of Condominium for Lakeview Condominium ("the Declaration") recorded simultaneously herewith in the public records of St. Johns County, Florida.

**Section Two. Applicability to Property.** The provisions of the Bylaws are applicable to the Lakeview of St. Augustine Condominium Association, Inc., ("the Association") and to the Condominium, which terms includes the land, the buildings, and all other improvements thereon, all easements, rights and appurtenances belonging thereto, and all other property, personal or mixed, intended for use in connection therewith.

**Section Three. Applicability to Persons.** All present and future Owners, lessees, and mortgagees, their employees, and any other person who may use the facilities of the Condominium in any manner shall be subject to these Bylaws, the Declaration, relevant Unit deeds, and the rules and regulations pertaining to the use and operation of the condominium property promulgated by the Association from time to time ("the Rules and Regulations").

**Section Four. Office.** The office of the Association shall be located at 3942 Highway A1A South, St. Augustine Beach, Florida 32080.

**Section Five. Definitions.** AElectronic Transmission@ or AElectronically Transmit@ refers to any form of communication, nor directly involving the physical transmission or transfer of paper, which creates a record that may be retained, retrieved, and reviewed by a recipient thereof and which may be directly reproduced in a comprehensible and legible paper form by such recipient through an automated process. All other capitalized terms not defined in these Bylaws shall have the meanings set forth in the Declaration or the Condominium Act.

**ARTICLE TWO: MEMBERSHIP**

**Section One. Members.** The Declarant and all record Owners of all Units in the Condominium shall be members of the Association, and no other persons or entities shall be entitled to membership. Membership shall be established by (i) the acquisition of Ownership of legal title to a Condominium Parcel, whether by conveyance, devise, judicial decree, or otherwise, subject to the provisions of these Bylaws, (ii) the recordation in the public records of St. Johns County, Florida, of the deed or other instrument establishing acquisition and designating the parcel affected thereby and (iii) the delivery to the Association of a true copy of such recorded deed or other instrument. The new Owner designated in such deed or other instrument shall thereupon become a member of the Association and the membership of the prior Owner as to the parcel designated shall be terminated.

**Section Two. Restraint Upon Assignment of Shares.** The shares of members in the funds and assets of the Association cannot be assigned, hypothecated, or transferred in any manner except as an appurtenance to a Unit.

**Section Three. Voting.** On all matters as to which the membership shall be entitled to vote, there shall be only one (1) vote for each Unit. Where a Unit is owned by a corporation, partnership or other legal entity or by more than one (1) person, all the Owners thereof shall be collectively entitled to the vote assigned to such Unit and such Owners shall, in writing, designate an individual who shall be entitled to cast the vote on behalf of the Owners of such Unit until such authorization is changed in writing. The term "Owner" as used herein shall be deemed to include the Declarant.

**ARTICLE THREE: FORM OF ADMINISTRATION**

**Section One. The Association and Board of Administration.** The affairs of the Condominium shall be administered and managed by an Association of Unit Owners organized as a Florida corporation not-for-profit, having the name Lakeview of St. Augustine Condominium Association, Inc. All power and authority of the Association shall be exercised through its Board of Administration (“the Board”), consisting of not less than three (3) members.

**Section Two. Composition of Board of Administration.** When Unit Owners other than the Developer own fifteen percent (15%) or more of the Units in the Condominium that will be operated ultimately by the Association, the Unit Owners other than the Developer shall be entitled to elect no less than one-third of the members of the Board of Administration of the Association. Unit Owners other than the Developer are entitled to elect not less than a majority of the members of the Board of Administration of the Association:

- a. Three years after fifty percent (50%) of the Units that will be operated ultimately by the Association have been conveyed to purchasers;
- b. Three months after ninety percent (90%) of the Units that will be operated ultimately by the Association have been conveyed to purchasers;
- c. When all of the Units that will be operated ultimately by the Association have been completed, some of them have been conveyed to purchasers, and none of the others are being offered for sale by the Developer in the ordinary course of business;
- d. When some of the Units have been conveyed to purchasers and none of the others are being constructed or offered for sale by the Developer in the ordinary course of business; or
- e. Seven years after recordation of the Declaration of Condominium creating the Condominium;

whichever occurs first. Persons elected to the Board of Unit Owners other than Developer shall be Owners of Units, or, in the case of corporate owners or mortgagees of Units, officers, directors, shareholders, or employees of such corporations. A person who has been convicted of any felony by any court of record in the United States and who has not had his or her right to vote restored pursuant to law in the jurisdiction of his or her residence is not eligible for Board membership. The validity of an action by the Board is not affected if it is later determined that a member of the Board is ineligible for Board membership due to having been convicted of a felony.

**Section Three. Powers and Duties.** The Board of Administration shall have the powers and duties necessary for the administration of the affairs of the Association and the Condominium and may do all such acts and things as are not directed to be exercised and done by the Unit Owners by law, the Declaration, or these Bylaws. The powers and duties to be exercised by the Board of Administration shall include, but shall not be limited, to the following (capitalized words and phrases shall have the meanings set forth in these Bylaws or the Declaration):

- a. Maintenance, repair, replacement, and cleaning of the Common Elements and Association Property;
- b. Determination, assessments, and collection of funds for Common Expenses, and payment of such expenses;
- c. Adoption, distribution, amendment, and enforcement of rules governing the use and operation of the Condominium and the use of the Common Elements, subject to the right of a majority of Unit Owners to change any such rules;
- d. Procurement and maintenance of insurance as hereinafter provided;
- e. Maintenance of accounting records for the Association, which records shall be made available for inspection by Unit Owners and mortgagees at all reasonable times;

f. Authorization and prosecution in the name of the Association of any and all actions and proceeding deemed necessary or appropriate in furtherance of the interests of Unit Owners generally, including suits to foreclose liens for non-payment of assessments or to recover money judgments for unpaid assessments;

g. Entry into any and all contracts deemed necessary or appropriate in furtherance of the interest of Unit Owners generally;

h. Employment and dismissal of personnel deemed necessary or appropriate for the maintenance and operation of the property, the Common Elements, and the Limited Common Elements;

i. Establishment of bank accounts in the name of the Association, and authorization of signatories therefor;

j. Purchasing, leasing or otherwise acquiring in the name of the Board of Administration, or its designee, corporate or otherwise, on behalf of all Unit Owners, Units offered for sale, lease, or surrender by their owners to the Board;

k. Purchasing Units at foreclosure or other judicial sale in the name of the Board of Administration or its designee, corporate or otherwise, on behalf of all Unit Owners;

l. Selling, leasing, mortgaging, or otherwise dealing with Units acquired by, and sub-leasing Units leased by, the Board of Administration or its designee, corporate or otherwise, on behalf of all Unit Owners;

m. Organizing corporations to act as designees of the Board of Administration in acquiring title to or leasing Units on behalf of all Unit Owners;

n. Contracting for repairs of, and additions and improvement to, the Association Property, and for repairs to, and restoration of, the property in accordance with the Provisions of these Bylaws, after damage or destruction by fire or other casualty, or as a result of condemnation or eminent domain proceedings;

o. Acquiring title to property or otherwise holding, leasing, mortgaging, or disposing of property in the Association's name for the use and benefit of its members; and

p. Conveying a portion of the Common Elements to a condemning authority for the purpose of providing utility easements, right-of-way expansion, or other public purposes, whether negotiated or as a result of eminent domain proceedings.

**Section Four. Election and Terms of Office.** Board members shall be elected in accordance with the procedure set forth in Article Five. The terms of all members of the Board shall expire upon the election of their successors at the annual meeting of the members. A vacancy on the Board caused by the expiration of a director's term shall be filled electing a new Board member, and the election shall be by secret ballot; however, if the number of vacancies equals or exceeds the number of candidates, no election is required.

**Section Five. Recall of Board Members.** Any member of the Board of Administration may be removed from office in accordance with the provisions of Section 718.112(2)(j), Florida Statutes (2004), as amended from time to time. Electronic Transmission may not be used as a method of giving notice of a meeting called in whole or in part for this purpose.

**Section Six. Organizational Meeting.** The first meeting of each Board of Administration shall be held within thirty (30) days after the election of such Board, at such place as may be fixed by the Board. Notice of the organizational meeting shall be given in accordance with Section Eleven below.

**Section Seven. Regular Meetings.** Regular meetings of the Board of Administration may be held at such times and places as shall from time to time be determined by the Board; provided, however, at least one (1) such meeting shall be held during each calendar year.

**Section Eight. Special Meetings.** Special meetings of the Board of Administration may be called by the President, and shall be called by the President or Secretary on the written request of a least two (2) Board members, on ten (10) days' notice to each Board member, given personally or by mail, telephone, or facsimile. Any such notice shall state the time, place and purpose of the meeting.

**Section Nine. Budget Meetings.**

**a. Regular Procedure.** Any meeting at which a proposed annual budget of the Association will be considered by the Board shall be open to all Unit Owners. At least fourteen (14) days prior to such meeting, the Board shall furnish a notice of such meeting and a copy of the proposed annual budget to each Unit Owner by hand delivery, Electronic Transmission, or by mail to the address last furnished to the Association. An officer or manager of the Association, or other person providing notice of such meeting, shall execute an affidavit evidencing compliance with such notice requirement and such affidavit shall be filed among the official records of the Association.

**b. Substitute Budget Procedure.** If in any fiscal year the Board adopts an annual budget which requires assessments against Unit Owners that exceed one hundred fifteen percent (115%) of assessments for the preceding fiscal year, the Board shall conduct a special meeting of the Unit Owners to consider a substitute budget if the Board receives, within twenty-one (21) days after adoption of the annual budget, a written request for a special meeting from at least ten percent of the voting interests. The special meeting shall be conducted within sixty (60) days after adoption of the annual budget. At least fourteen (14) days prior to such special meeting, the Board shall furnish a notice of the meeting to each Unit Owner by hand delivery, Electronic Transmission, or by mail to the address last furnished to the Association. An officer or manager of the Association, or other person providing notice of such meeting, shall execute an affidavit evidencing compliance with such notice requirement and such affidavit shall be filed among the official records of the Association. Unit Owners may consider and adopt a substitute budget at the special meeting. A substitute budget is adopted if approved by a majority of all voting interests. If there is not a quorum at the special meeting or the substitute budget is not approved, the annual budget previously adopted by the Board shall take effect as scheduled.

**c. Developer Budget.** If the Developer controls the Board, assessments shall not exceed one hundred fifteen percent (115%) of assessments for the prior fiscal year unless approved by a majority of all voting interests.

Any determination of whether assessments exceed one hundred fifteen percent (115%) of assessments for the prior fiscal year shall exclude any authorized provision for reasonable reserves for repair or replacement of the Condominium Property, anticipated expenses of the Association which the Board does not expect to be incurred on a regular or annual basis, or assessments for betterments to the Condominium Property.

**Section Ten. Waiver of Notice.** Any Board member may at any time waive notice of any meeting of the Board, in writing, and any such written waiver shall be deemed equivalent to the giving of the notice required herein. Attendance of any Board meeting by a member shall constitute a waiver by him or her of notice of the time and place thereof.

**Section Eleven. Notice of Board Meetings.** Adequate notice of all meetings of the Board of Administration, which shall specifically incorporate an identification of agenda items, shall be posted conspicuously on the Condominium property at least 48 continuous hours preceding the meeting except in an emergency. Any item not included on the notice may be taken up on an emergency basis by at least a majority plus one of the members of the Board. Such emergency action shall be noticed and ratified at the next regular meeting of the Board. Written notice of any meeting at which non-emergency special assessments or amendment to rules regarding Unit use will be considered shall be mailed, delivered, or Electronically

Transmitted to the Unit Owners and posted conspicuously on the condominium property not less than fourteen (14) days prior to the meeting. Notice of any meeting at which regular assessments against Unit Owners are to be considered for any reason shall specifically contain a statement that assessments will be considered and the nature of any such assessments. Notice of meetings of the Board and committees may only be given by Electronic Transmission to those Unit Owners who have consented to receive notices by Electronic Transmission.

**Section Twelve.** **Quorum.** At all meetings of the Board of Administration, a majority of the Board shall constitute a quorum for the transaction of business, and the acts of a majority of the members present at a meeting at which a quorum is present shall constitute the acts of the Board. If at any meetings of the Board of Administration there be less than a quorum present, a majority of those present may adjourn the meeting from time to time.

**Section Thirteen.** **Minutes.** Minutes shall be taken at all meetings of the Board of Administration. Copies of the minutes shall be available for inspection at the office of the Association by Unit Owners and Board members at all reasonable times.

**Section Fourteen.** **Attendance by Unit Owners.** Meetings of the Board of Administration and any committee thereof at which a quorum is present shall be open to all Unit Owners, except meetings between the Board or Committee and the Association's attorney with respect to proposed or pending litigation when the meeting is held for the purpose of seeking or rendering legal advice. Any Unit Owner may tape record or videotape meetings of the Board and may speak at such meetings with reference to all designated agenda items. The Board may adopt reasonable rules and regulations governing the frequency, duration, and manner of Unit Owner statements and governing the tape recording and videotaping of the meeting.

**Section Fifteen.** **Compensation.** The members of the Board of Administration shall serve without compensation.

#### ARTICLE FOUR: OFFICERS

**Section One.** **Designation.** The principal officers of the Association shall be a President, Secretary and Treasurer, all of whom shall be elected by and from the Board of Administration.

**Section Two.** **Election of Officers.** The Officers of the Association shall be elected annually by the Board of Administration at its organizational meeting, and shall hold office at the pleasure of the Board.

**Section Three.** **Removal of Officers.** On the affirmative vote of a majority of the members of the Board of Administration, any officer may be removed, with or without cause, and his successor may be elected at any regular meeting of the Board or at any special meeting of the Board called for that purpose.

**Section Four.** **President.** The President shall be the chief executive officer of the Association. He shall preside at all meetings of the Board of Administration and of Unit Owners. He shall have all general powers and duties that are incident to the office of President of a Florida non-profit corporation, including, without limitation, the power to appoint committees from among the Owners from time to time as he may deem appropriate to assist in the conduct of the affairs of the Association.

**Section Five.** **Secretary.** The Secretary shall keep the minutes of all meetings of the Board of Administration and of Unit Owners, shall have charge of such books and papers as the Board of Administration may determine and shall, in general, perform all duties incident of the office of Secretary of a Florida non-profit corporation.

**Section Six.** **Treasurer.** The Treasurer shall have responsibility for the funds and securities of the Association and the Condominium, for keeping full and accurate accounts showing all receipts and disbursements, and for the preparation of all necessary financial statements. He shall be responsible for the deposit of all moneys and other valuable effects in



the name of the Board of Administration, and shall, in general, perform all duties incident of the office of Treasurer of a Florida non-profit corporation.

**Section Seven.**      **Compensation.** The officers shall serve without compensation.

#### ARTICLE FIVE: UNIT OWNERS

**Section One.**      **Annual meetings.** The annual meetings of the Unit Owners shall be held on a day designated by the Board in October of each year.

**Section Two.**      **Elections.** The regular election shall occur on the date of the annual meeting in accordance with the following procedure:

a.      **Voting.** The members of the Board shall be elected by written ballot or voting machine. Elections shall be decided by a plurality of those ballots cast. There shall be no quorum requirement; however, at least twenty percent (20%) of the eligible voters must cast a ballot in order to have a valid election of members of the Board. No Unit Owner shall permit any other person to vote his or her ballot, and any such ballots improperly cast shall be deemed invalid. Any Unit Owner who permits another to vote his or her ballot may be fined by the Association in accordance with Section 718.303, Florida Statutes (2004), as amended from time to time. A Unit Owner needing assistance in casting the ballot for the reasons stated in Section 101.051, Florida Statutes (2004), as amended from time to time, may obtain assistance in casting the ballot.

b.      **Notice.** Not less than sixty days before a scheduled election, the Association shall mail, deliver or Electronically Transmit to each Unit Owner entitled to a vote a first notice of the date of the election, which must contain the correct mailing address of the Association. Any Unit Owner or other eligible person desiring to be a candidate for the Board must give written notice to the Association not less than forty (40) days before a scheduled election. At least fourteen (14) days before the election, the Association shall mail, deliver, or Electronically Transmit a second notice of the election, together with an agenda and a ballot listing all candidates, to all Unit Owners entitled to vote therein.

c.      **Candidate Information Sheet.** Upon request of a candidate, the Association shall include with the second notice of the election a candidate information sheet. The information sheet may not be larger than 8 ½ by 11 inches and must be furnished by the candidate not less than thirty-five (35) days before the election to be included with the mailing of the ballot. The Association may not edit, alter, or otherwise modify the contents of the information sheet, and the original information sheet shall become part of the official records of the Association. The Association is not liable for the contents of the information sheets prepared by the candidates. The cost of mailing, delivering, or Electronically Transmitting the information sheet shall be borne by the Association.

Notwithstanding the foregoing, an election is not required unless more candidates file notices of intent to run or are nominated than Board of Administration vacancies exist.

**Section Three.**      **Special Meetings.** The President may, and, if directed by resolution of the Board of Administration or by petition signed and presented to the Secretary/Treasurer by Unit Owners owning a total of at least two-thirds (2/3) of the common interest, shall, call a special meeting of Unit Owners. No business shall be transacted at a special meeting except as stated in the notice unless by consent, either in person or by proxy, of Unit Owners owning at least two-thirds (2/3) of the common interest.

**Section Four.**      **Place of Meetings.** Meetings of Unit Owners shall be held at the principal office of the Association, or at such other suitable place convenient to the Owners as may be designated by the Board of Administration.

**Section Five.**      **Notice of Unit Owner Meetings.** Written notice including an agenda and stating the place, day, and hour of the meeting and, in the case of a special meeting, stating the purpose or purposes for which the meeting is called, shall be mailed, hand delivered, or Electronically Transmitted to each Unit Owner at the address last furnished to the Association

by the Unit Owner or hand delivered to each Unit Owner at least fourteen (14) days prior to the meeting and shall be posted in a conspicuous place on the condominium property at least fourteen (14) continuous days preceding the meeting. Upon notice to the Unit Owners, the Board shall by duly adopted rule designate a specific location on the Condominium Property upon which all notices of Unit Owner meetings shall be posted. Unit Owners may waive notice of specific meetings.

**Section Six. Quorum.** At all meetings of Unit Owners at which a quorum is required, a majority of Unit Owners shall constitute a quorum for transaction of business. If, at any meeting of Unit Owners at which a quorum is required, less than a quorum is present, a majority of those present may adjourn the meeting to a time not less than forty-eight (48) hours from the time the original meeting was called.

**Section Seven. Order of Business.** The order of business at all meetings of Unit Owners shall be as follows:

- a. Collection of election ballots.
- b. Roll call.
- c. Proof of notice of meeting or waiver of notice.
- d. Reading of minutes of preceding meeting.
- e. Reports of officers.
- f. Reports of Board of Administration.
- g. Reports of committees.
- h. Election of inspectors of election (when appropriate).
- i. Election of members of Board of Administration (when required).
- j. Unfinished business.
- k. New business.

**Section Eight. Proxies.** Except as otherwise specifically provided in the Condominium Act and these Bylaws, Unit Owners may not vote by general proxy, but may vote by limited proxies substantially conforming to a limited proxy form adopted from time to time by the Division of Florida Land Sales, Condominiums, and Mobile Homes. Limited and general proxies may be used to establish a quorum. Limited proxies may be used for any matter for which the Condominium Act requires or permits a vote of the Unit Owners unless the use of a proxy is specifically prohibited by the Condominium Act or by these Bylaws. General proxies may be used for other matters for which limited proxies are not required, and may also be used in voting for nonsubstantive changes to items for which a limited proxy is required and given. No proxy, limited or general, may be used in the election of Board members or to fill vacancies on the Board of Administration unless permitted by the Condominium Act. Notwithstanding the provisions of this section, Unit Owners may vote in person at Unit Owner meetings.

**Section Nine. Minutes.** Minutes shall be taken at all meetings of Unit Owners. Copies of the minutes shall be available for inspection at the office of the Association by Unit Owners and members of the Board of Administration at all reasonable times.

**Section Ten. Unit Owner Participation.** Unit Owners shall have the right to participate in meetings of Unit Owners with reference to all designated agenda items and may tape record or videotape any meeting of the Unit Owners. The Association may adopt reasonable rules governing the frequency, duration, and manner of Unit Owner participation in Unit Owner meetings and governing tape recording or videotaping of Unit Owner Meetings.

**Section Eleven. Approval by Unit Owners.** Any approval by Unit Owners required by the Condominium Act, the Declaration of Condominium or these Bylaws shall be made at a duly noticed meeting of Unit Owners, which notice shall specifically incorporate an identification of agenda items, and shall be subject to all requirements of the Condominium Act, the Declaration, and these Bylaws, provided that Unit Owners may take action by written agreement without a meeting on any matter that requires the approval of the Unit Owners as provided by Section 718.112(2)(d)(4), Florida Statutes (2004).

## **ARTICLE SIX: OPERATION OF PROPERTY**

**Section One. Share of Common Expenses and Common Surplus.** Appurtenant to each Condominium Parcel shall be an undivided share in the Common Elements and Common Surplus and an undivided share of liability for the Common Expenses. Each Owner shall own an undivided share in the Common Elements and Common Surplus of the Condominium and an undivided share of the liability for Common Expenses. The ownership share of the Common Elements and Common Surplus and share of liability for the Common Expenses assigned to each Unit shall be based upon the total square footage of each Unit in uniform relationship to the total square footage of each other Unit and is set forth in the Unit Identification and Schedule of Shares attached as Exhibit B to the Declaration.

**Section Two. Determination of the Common Expenses.** Each year the Board of Administration shall prepare detailed proposed budgets of Common Expenses for the Association. The Association's budget shall contain estimates of the cost of performing the functions of the Association, including without limitation the estimated amounts necessary for maintenance and operation of Association Property, landscaping, streets and walkways, office expenses, utility services, replacement reserves, casualty insurance, liability insurance, and administration salaries, and other expenses required by the Condominium Act. All budgets shall show the amounts budgeted by accounts and expense classifications and shall include projections of Common Expenses, common revenues (from sources, if any, other than assessments of Unit Owners), the amount of common charges required to meet the excess of the former over the latter, and an allocation and assessment of such common charges against Unit Owners as provided in these Bylaws and the Declaration of Condominium. The final annual budgets shall be adopted by the Board after consideration at a meeting held pursuant to Article Three, Section Nine.

After adoption of the budgets and determination of the annual Assessments per Unit, the Association shall assess such sums by promptly notifying all Owners by delivering or mailing notice thereof to the voting member representing each Unit at such member's most recent address as shown by the books and records of the Association. One-twelfth (1/12) of the Association's annual assessments shall be due and payable in advance to the Association on the first day of each month.

As used in these Bylaws, the term "Common Expenses" shall include, but shall not be limited to the following:

- a. All expenses of administration, maintenance, repair and replacement of the Association Property and the Common Elements of the Condominium.
- b. Insurance premiums on all policies of insurance obtained by the Board of Administration, managing agent or manager, as the case may be.
- c. Working capital reserve and contingency account.
- d. General operating expenses.
- e. Repair and replacement reserve.
- f. Reserve for deficits accrued in prior years.

g. Reserve for acquisition or lease of Units, the Owners of which have elected to sell or lease the same, or that may become available at foreclosure or other judicial sale.

h. Utility rates for water and gas, and related sewer rents.

i. Utility rates for electricity serving the Common Elements, other than leased portions thereof, which shall be separately metered.

j. All other amounts that the Owners may agree upon or that the Board of Administration may deem necessary or appropriate for the operation, administration, and maintenance of the Association and Condominium.

k. All other amounts designated Common Expenses by the Declaration, by these Bylaws, or the Condominium Act.

**Section Three. Reserves.** The Condominium budget shall include reserve accounts for capital expenditures and deferred maintenance. These reserve accounts shall include but are not limited to, roof replacement, building painting and pavement resurfacing reserves and any other item for which the deferred maintenance expense or replacement cost exceeds \$10,000. The Association may adjust replacement reserve assessments annually to take into account any extension of the useful life of a reserve item caused by deferred maintenance. Reserve funds and any interest thereon shall remain in the reserve accounts and shall be used only for authorized reserve expenditures unless their use for other purposes has been approved in advance by a majority vote at a duly called meeting of the Association. This subsection does not apply to an adopted budget in which the Members have determined, by a majority vote at a duly called meeting of the Association, to provide no reserves or less reserves required by this subsection. Prior to turnover of control of the Association by the Developer, the Developer may vote to waive the reserves or reduce funding of reserves for the first two (2) fiscal years of the Association's operation, beginning with the fiscal year in which the initial Declaration is recorded. Any vote to waive or reduce reserves shall be effective for only one annual budget.

**Section Four. Special Assessments.** Special Assessments may be made by the Board of Administration from time to time to meet other needs or requirements of the Association and to provide for emergency repair or replacement of Association Property and infrequently recurring items of maintenance. However, any special Assessments which are not connected with an actual operating, managerial, or maintenance Common Expense shall not be levied without the prior approval of the majority of the members of the Association.

**Section Five. Non-Waiver.** The liability for Assessments may not be avoided by waiver of the use or enjoyment of any Association Property.

**Section Six. Collection of Assessments.** The Board of Administration shall, by suitable written notice, assess Common Expenses against Condominium Parcels monthly, on the first day of each month, each such assessment covering the next succeeding month. If any such installment remains unpaid for more than ten (10) days from the date due, the Board of Administration shall take prompt action to collect it.

**Section Seven. Common Surplus.** If in any taxable year the net receipts of the Association from assessments and all other sources except casualty insurance proceeds and other non-recurring items exceeds the sum of (a) total Common Expenses for which payment has been made or liability incurred within the taxable year, and (b) reasonable reserves for Common Expenses and other liabilities in the next succeeding taxable year as may be determined by the Board of Administration, such excess shall be retained and applied to lessen the assessments for the next year, the amount of such reduction for each Unit Owner being in proportion to his undivided interest in the Common Elements.

**Section Eight. Liability for Assessments.** All Unit Owners are jointly and severally obligated to pay the Common Expenses assessed by the Board of Administration at the times set forth in these Bylaws. No Unit Owner may exempt himself from liability for any

assessment for Common Expenses by waiver of use or enjoyment of any of the Association Property or Common Elements or by abandonment of his Unit.

**Section Nine. Default in Payment of Common Expenses.** In the event a Unit Owner shall fail, for thirty (30) days following the due date thereof, to pay to the Board of Administration the Common Expenses assessed against his Unit, such Unit Owner shall be deemed in default, and shall be obligated to pay interest at the highest rate allowed by law on such Common Expenses from the due date thereof, together with all administrative late fees and expenses, including reasonable attorneys' fees, incurred by the Board of Administration in any proceeding brought to collect the same, or to foreclose a lien for nonpayment thereof.

**Section Ten. Foreclosure of Liens for Unpaid Common Expenses.** The Board of Administration may bring an action to foreclose any lien for unpaid Common Expenses in the manner that a mortgage of real property is foreclosed or it may bring an action to recover a money judgment for the unpaid assessment without waiving any claim of lien. The Board shall give notice to the Unit Owner of its intention to foreclose its lien at least thirty (30) days before the foreclosure action is filed. The notice shall be given by personal delivery or by certified mail, return receipt requested, addressed to the Unit Owner.

**Section Eleven. Use of Units; Rules and Regulations.** The use of Units and the Common Elements shall be subject to reasonable restrictions set forth in the Declaration and the Rules and Regulations promulgated and amended from time to time by the Board of Directors with the approval of a majority of Unit Owners. Copies of all such rules and regulations shall be furnished to each Unit Owner prior to their effective date.

#### ARTICLE SEVEN: RECORDS

**Section One. Records; Certification.** The Board of Administration shall keep detailed records of all actions of such Board, including financial records and books of account of the Association. Such records shall include a chronological record of all receipts and disbursements. A separate account shall also be kept for each Condominium Parcel containing, among other things, the amount of each assessment against such Condominium Parcel, the date when due, amounts paid thereon, and the balance remaining due. The Board of Administration shall also prepare a quarterly written report summarizing receipts and disbursements of the Association, copies of which shall be made available to all Unit Owners. Additionally, an annual report of receipts and disbursements of the Condominium or a complete set of financial statements shall be rendered by the Board of Administration to all Unit Owners and mortgagees requesting the same promptly after the end of each fiscal year.

**Section Two. Certificate of Compliance.** A certificate of compliance from a licensed electrical contractor may be accepted by the Board as evidence of compliance by the Condominium Units to the applicable fire and life safety codes.

#### ARTICLE EIGHT: DISPUTE RESOLUTION

**Section One. Written Inquiries.** When a Unit Owner files a written inquiry by certified mail with the Board of Administration, the Board shall respond in writing to the Unit Owner within thirty (30) days of receipt of the inquiry. The Board's response shall either give a substantive response to the inquirer, notify the inquirer that a legal opinion has been requested, or notify the inquirer that advice has been requested from the division. If the Board requests advice from the division, the Board shall, within ten (10) days of its receipt of the advice, provide in writing a substantive response to the inquirer. If a legal opinion is requested, the Board shall, within sixty (60) days after the receipt of the inquiry, provide in writing a substantive response to the inquiry. The failure to provide in writing a substantive response to the inquiry as provided herein precludes the Board from recovering attorney's fees and costs in any subsequent litigation, administrative proceeding, or arbitration arising out of the inquiry. The Association may through its Board of Administration adopt reasonable rules and regulations regarding the frequency and manner of responding to Unit Owner inquiries, one of which may be that the Association is only obligated to respond to one written inquiry per Unit in any given thirty (30) day period. In such a case, any additional inquiry must be responded to in the subsequent thirty (30) day period, or periods, as applicable.

**Section Two. Disputes Between Unit Owners and Association.** Prior to the institution of any litigation between a Unit Owner and the Association, the parties shall petition the Division of Florida Land Sales, Condominiums and Mobile Homes for nonbinding arbitration. Arbitration shall be conducted according to the rules promulgated by the Division and in accordance with the procedure set forth in Chapter 718.1255, Florida Statutes (2004), as amended from time to time.

**Section Three. Fines.** The Association may levy reasonable fines against a Condominium Parcel for the failure of the Unit Owner or its occupant, licensee, or invitee, to comply with any provision of the Declaration of Condominium, Bylaws or reasonable rule of the Association in accordance with the procedure set forth in Section 718.303, Florida Statutes (2004), as amended from time to time.

**ARTICLE NINE: MISCELLANEOUS**

**Section One. Notices.** All notices required or permitted to be sent to the Board of Administration shall be sent by registered or certified mail to the office of the Board, or to such other address as such Owner may have designated, in writing, to the Board. All notices required or permitted to be sent to a Unit Owner shall be sent to the address last furnished to the Association by the Unit Owner. All notices to Unit mortgagees shall be sent by registered or certified mail to their respective addresses as maintained by the Secretary. All notices shall be deemed to have been given when mailed, except notices of change of address which shall be deemed to have been given when received.

**Section Two. Waiver.** No restriction, condition, obligation or provision contained in these Bylaws shall be deemed to have been abrogated or waived by reason of any failure to enforce the same, irrespective of the number of violations and failures to enforce that may occur.

**Section Three. Invalidity.** If any provision or provisions of these Bylaws is, or are, declared invalid, such invalidity shall in no way impair or affect the validity, enforceability, or effect of the remaining provisions of these Bylaws.

**Section Four. Captions.** Captions are inserted in these Bylaws for convenience and reference only, and shall not be taken in any way to limit or describe the scope of these Bylaws or any provision hereof.

**Section Five. Conduct of Meetings.** Roberts' Rules of Order (latest edition) shall govern the conduct of the Association's meetings when not in conflict with the Condominium Act, the Declaration, Articles of Incorporation, or these Bylaws.

**Section Six. Priorities in Case of Conflict.** In the event of conflict between or among the provisions of any of the following, the order of priorities shall be from highest priority to lowest:

- a. The Declaration of Condominium
- b. The Articles of Incorporation
- c. The Bylaws
- d. The Rules and Regulations

**Section Seven. Electronic Transmission.** The Board shall adopt rules and procedures for giving notice of meetings of the Board, committees, and Unit Owners by Electronic Transmission in a manner authorized by law.

**ARTICLE TEN: AMENDMENT**

**Section One. Amendments.** These Bylaws may be amended or supplemented by the vote of Unit Owners entitled to exercise two-thirds (2/3) or more of the total voting power of the Association at a meeting of Unit Owners duly called and held for such purpose. No amendment shall be made that is in conflict with the Declaration, nor shall any amendment alter, abridge or amend the rights of the Developer or mortgagees of Units without their consent. Any such amendment or supplement shall be filed or recorded in the office in which the Declaration and a copy of these bylaws are recorded.

IN WITNESS WHEREOF, We, being all of the Directors of Lakeview of St. Augustine Condominium Association, Inc., have hereunto set our hands this 26 day of MAY 2005, 2005.

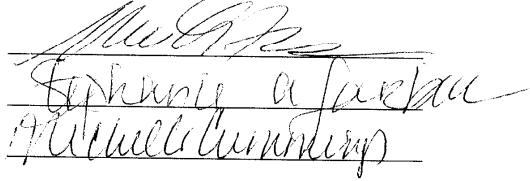
  
\_\_\_\_\_  
\_\_\_\_\_  
\_\_\_\_\_  
\_\_\_\_\_

**CERTIFICATE**

I, the undersigned, do hereby certify:

That I am the duly elected and acting Secretary of Lakeview of St. Augustine Condominium Association, Inc., a Florida non-profit corporation, and,

That the foregoing Bylaws constitute the original Bylaws of said Association, as duly adopted at a meeting of the Board of Directors, held on the 26<sup>th</sup> day of May, 2004.

IN WITNESS WHEREOF, I have hereunto subscribed my name and affixed the seal of said Association this 26 day of MAY, 2005.

  
\_\_\_\_\_  
CURTIS L. FRAZIER

Its: Secretary

(Corporate Seal)